

# LANDTMETERS NAVAL STORES

BROUWERSVLIET, 11 ANTWERPEN (BELGIE)

TEL. <sup>(03)</sup> 33 62 33  
<sub>(03)</sub> 33 71 91



SCHEEPSBENODIGDHEDEN  
FOURNITURES DE MARINE

KATALOGUS EDIT. 1963

V L A A M S I N H O U D S T A B E L

A	Blz.	B	Blz.
Aangroeiwerende verf	76	Brandblussers	75
Aanvaarzakken	28	Brillen Veiligheids-	44
Achterfenders	28	Broekstropen	25
Achterlichten	66/67	Buis vr. touwstrop	41
Ankerboeien	51	Buiten Boord Motoren	81
Ankerlantaarns	66/67		
Ankerlieren	51	C	
Ankers " Danforth "	50		
Ankers Drijf-	62	Carbolineum	77
Ankers Klip-	50	C Haken	26
Ankers Prop-	51	Clubvlaggen	30
Ankers Stok-	50	Cocokeerborstels	74
Antislipverf	76	Cocomatten	23
Assezakken	28	Cocovezels	23
		Codeboeken	33
B		Codevlaggen	30
		Copperpaint	76
Balanceerlampen	65		
Bekers	62	D	
Bensellijn Ijzere	22		
Beschuiten	63	Danforth Ankers	50
Beschuittanks	63	Darmen vr. Bootspompen	68
Bestrijksel vr. zeilen	80	Darmklemmen	68
Bieënwas	27	Dekstenen	78
Bijlen	64	Dekstoppen	49
Bindgaren	22	Dekzeilen	35
Blanke Staaldraad	20	Dekventilatoren	71
Blokjes koper	57	Diepzeeloodlijn	73
Blokjes Yacht-	58	Dierenvet	80
Blokken Houten	59	Dippers	62
Blokken vr. kemptouwwerk	56/59	Doek	34/35
Blokken vr. staaldraad	52/55	Doek Vlaggen-	31
Blokken verzinkte	57	Dollen Roeijzers-	45
Blokken Voet-	55	Draadlieren	53
Boegklampen	48	Dreggen	50
Boeien Anker-	51	Drijfankers	62
Boeienlint	35	Drijvende werplijnen	22
Boeien Reddings-	29	D schakels	36
Boeisluitingen	37	Dubbele Kruisbolders	48
Bokkepootjes	75	Dynamobouten	39
Bolders	48		
Bollantaarns	66	E	
Boordlantaarns	66/67	Emmers	68
Bootshaken	44		
Bootsmanstoel	33	F	
Bootsnagelen	60		
Bootspompen	68	Fakkels	69
Bootstoppen	64	Fenders	28
Borstels	74	Ferrofix	77
Borstelstelen	74	Filaskoord	23
		Formflex	79/80

V L A A M S I N H O U D S T A B E L

G	Blz.	K	Blz.
Garen Zeil-	22	Kabelsokken	41
Gasverstellers	72	Kalfaathamers	78
Gegalvan. Blokken	57	Kalfaatkatoen	78
Gegalvan. Emmers	68	Kalfaatwerk	78
Gegalvan. Staaldraad	20/21	Kalfaatijzers	78
Gekaarde Kemp	23	Kannen Olie-	69
Gelade Bomen	44	Kano's	80
Gietijzeren Kousen	41	Karabijnhaken	46
Glijleuvers	47	Katoendoek	34
Gordels Reddings-	29	Keerborstels	74
		Kelven	36/37
		Kemp Gekaarde	23
H		Kettingen	51
Haakstelen	44	Kettinghaken	52
Haarvilt	23	Kettingkluisen	49
Haken Boots-	44	Kettinglengen	26
Haken Karabijn-	46	Kettingstoppers	51
Haken Laad-	38	Kettingwartels	52
Haken Zeil-	27	Kikkers	48
Hamers Kleed-	27	Kistenlengen	26
Hamers Pik-	44	Klauwen vr. bomen	44
Handbijlen	64	Kleehamers	27
Handloodlijn	73	Klemmen vr. staaldraad	42
Handpalmen	27	Klepleuvers	46
Handschuurborstels	74	Klepschroeven	42
Handvatten vr. grijplijn	64	Klipankers	50
Handvleugels	74	Kliphaken	46
Hangerblokken	54	Klokken	69
Hangerkettingen	51	Knalsignalen	70
Harpschakels	37	Koeivoeten	75
Heklantaarns	66/67	Kompassen	73
Hijsblokken vr. kemptouw	56/59	Koolpek	77
Hijsblokken vr. staaldraad	52/55	Koolteer	77
Hijshaken	38	Koordladders	33
Hoosvaten	64	Kopere blokjes	57
Houten blokken	59	Kopere schakels	46
Houten spieën	59	Kopere sluitringen	60
Huising	22	Kordeel	22
Hydro	76	Kousen gietijzere	41
		Kousen vr. kemptouwwerk	40
		Kousen ronde	41
I		Kousen vr. staaldraad	40
Ijzere bensellijn	22	Kousen vr. toogtrossen	41
Inpakdoek	35	Kousjes Zeil-	75
Intern. Codevlaggen	30	Kruisbolders	48
		Kurkzakken	28
J			
Jerrycans	80		

REPertoire FRANCAIS Pages 6/9  
 ENGLIS INDEX Pages 10/14  
 DEUTSCHES INHALTVERZEICHNIS Seiten 15/18

V L A A M S I N H O U D S T A B E L

L	Blz.	M	Blz.
Laadblokken	54	Messen Scouts-	27
Laadhaken	38	Messen vr. Staaldraadkap.	39
Laadnetten	24	Messen Zeemans-	27
Laadsangel	25	Meters Lint-	72
Ladders Koord-	33	Misthoorns	69
Laddersspieën	33	Motoren Buiten Boord	81
Lak Yacht-	76	Muurlieren	56
Lampen	65		
Langogige Wartels	52	N	
Lantaarns	66/67		
Ledige Bomen	44	Naalden	27
Lengen	24/26	Nagelen Boot-	60
Leiblokken	54	Netten Laad-	24
Leuvers Glij-	47	Noodseinen	70
Leuvers Stag-	46		
Lichten Rode	70	O	
Lichtranden	71		
Lieren Anker-	51	Oliekannen	69
Lieren Draad-	53	Oliepompen	68
Lieren Muur-	56	Oliezakken	62
Lijm Textiel-	80	Ondermessen vr. draadkap.	39
Lijnen Lood-	73	Ontverver	76
Lijnen Vlag-	19	Oogbouten vr. Dynamos	39
Lijnen Vlottende Werp-	22	Oogbouten vr. grijplijnen	64
Lijnen Werp-	19	Oogbouten kopere	49
Lijnen Weve-	19	Oogbouten ovale	39
Lint Boeien-	35	Oogplaten	49
Lintmeters	72		
Liquid Marine Glue	76	P	
Loodlijnen	73		
Loodlijnwielen	73	Paddels	63
Luchthelmen	71	Palmen Hand-	27
Lucifers	70	Patentrevers	47
Luikspieën	59	Patrijspoorten	71
		Peillooden	73
M		Peilstokken	72
		Pek	77
Machienkamerlantaarns	65	Peklepels	78
Manilatouwwerk	19	Pekpotten	78
Marlin	22	Petroolkannen	69
Marine Glues (Pek)	77	Pikhamers	44
Marine Glues (Verscheidene)	76/77	Plaatschalmen	52
Mastbanden	47	Platenlengen	26
Mastellen	45	Platen vr. roeijzers	45
Mastiek	77	Platte ringen	71
Mastkralen	45	Poetskatoen	23
Mastlichten	66/67	Pompen	68
Mastrail	47	Presenningdoek	35
Mastringen	47	Presenningen	35
Matrijzen vr. kousjes	75	Priemen Splits-	27
Matten Coco-	23	Propankers	51

REPertoire FRANCAIS Pages 6/9  
 ENGLISH INDEX Pages 10/14  
 Deutsches INHALTVERZEICHNIS Seiten 15/18

V L A A M S I N H O U D S T A B E L

P	Blz.	S	Blz.
Puntdreggen	50	Schootogen	49
Puntkousen	40	Schootringen	47
		Schotlampen	65
R		Schrabbers	44
Ramen vr. dekstenen	78	Schroefteerkoppen	74
Ratteschermen	60	Schuurborstels	74
Rechte sluitingen	36	Schuursteenijzers	78
Reddingsboeien	29	Schuurstenen	78
Reddingsboeilichten	70	Scoutsmessen	27
Reddingsgordels	29	Seamflex	77
Reddingshaken	44	Seinboeken	33
Riemen Roei-	63	Seinvlaggen	30
Ringbouten vr. grijplijnen	64	Signaalballons	69
Ringen platte koperen	71	Signaallantaarns	67
Ringen ronde stalen	38	Signaalspiegels	70
Ringplaten	49	Signaalvlaggen	30
Riveerhaken	38	Signalen Nood-	70
Rode lichten	70	Singel	35
Roeijzers	45	Sleeophaken	46
Roeijzersdollen	45	Sluitingen	36/37
Roeijzersplaten	45	Sluitringen	60
Roeiriemen	63	Smeeroliekannen	68
Roephoorns	69	Sokken Kabel-	41
Roeststekers	44	Spanschroeven	42
Roestvrije staaldraad	21	Spieën Luik-	59
Roestwerende verf	76	Spieën Vangenlijn-	64
Ronde kousen	41	Spiegels	70
Rooksignalen	70	Splischalmen	37
		Splitspriemen	27
S		Springlay touw	22
		Staaldraadblokken	52/55
Schakels koperen	46	Staaldraadkappers	39
Schakelsleutel	46	Staaldraadkabels	20/21
Schakels stalen	36/37	Staaldraadklemmen	42
Schalmen	37	Staande Want	20
Scharen Wiek-	65	Stagleuvers	46
Scheden vr. messen	27	Stalen borstels	74
Scheepslantaarns	66	Stelen Borstel-	74
Scheepslichten	65	Stelen Dekschuur-	78
Scheepsloggen	73	Stelen Haak-	44
Scheepsvilt	23	Stelen vr. teerkoppen	74
Scheepswerk	78	Step on it pompen	68
Schiemansgaren	22	Stokankers	50
Schijfbussen	60	Stokdweilen	75
Schijven vr. kemptouw	60/61	Stokdweilstelen	75
Schijven vr. staaldraad	61	Stopschalmen	37
Schootklemmen	49	Stormlantaarns	65
		Straatkeerders	74

REPertoire FRANCAIS Pages 6/9

ENGLISH INDEX Pages 10/14

DEUTSCHES INHALTVERZEICHNIS Seiten 15/18

V L A A M S I N H O U D S T A B E L

S	Blz.	V	Blz.
Stroppen	24/25	Visolie	80
Stuurlichten	65	Vlaggelijnen	19
Stuurraderen	72	Vlaggen	30/32
		Vlaggendoek	31
T		Vlaggenstokhouders	47
		Vlagwartels	33
Taliehaken	38	Vleugelpompen	68
Taluritiklemmen	24	Vodden	23
Tandwieltakels	54	Voetblokken	55
Teer	77	Vóórfenders	28
Teerkoppen	74	Vouwbare dreggen	50
Tegenwichten	39	Vouwbare peilstokken	72
Telegraafketting	70	Vuurpijlen	70
Textiellijm	80		
Tirkabel	22		
Toortslampen	65	W	
Toplantaarns	66/67	Wantschroeven	42/43
Touwmeters	72	Wartels Ketting-	52
Touwwerk geslagen	19	Wartels Vlagge-	33
Touwwerk gevlochten	23	Was Bieën-	27
Touwwerk katoen	19	Waterdarmen vr. pompen	68
Touwwerk Kemp	19	Waterdippers	62
Touwwerk Manila	19	Watertanks	62
Touwwerk Nylon	19	Watervaten	62
Touwwerk Staaldraad	20/21	Werk Kalfaat-	78
Trappen	33	Werplijnen	19
Trechters	69	Werplijnen Drijvende	22
Treden	33	Wevelijnen	19
Triangelplaten	54	Wiekschaar	65
Tweekleurlantaarns	66	Windwijzers	30
Twist	23	Witte vodden	23
U		Y	
Umea Teer	77	Yachtblokjes	58
		Yachtdoek	34
V		Yachtfenders	28
Valschermsignalen	70	Yachtlak	76
Veiligheidsbanden	28	Yachtlantaarns	67
Veiligheidsbrillen	44	Yachtvernis	76
Ventilatierozetten	70		
Verbindingnippels vr. telegraafketting	70	Z	
Vernis Yacht-	76	Zaknaalden	27
Vernis Zwarte	77	Zakken Asse-	28
Verwen	76	Zeeankers	62
Vet	80	Zeemansmessen	27
Vilt	23	Zeildoek	34/35
Visbouten	45	Zeilgaren	22
		Zeilhaken	27

REPertoire FRANCAIS Pages 6/9  
 ENGLISH INDEX Pages 10/14  
 DEUTSCHES INHALTVERZEICHNIS Seiten 15/18

V L A A M S I N H O U D S T A B E L

Z Blz.

Zeilkousjes	75
Zeilnaalden	27
Zijdedolhouders	45
Zijlichten	66/67
Zwarte vernis	77
Zweedse Pek	77
Zweeds teer	77

REPertoire FRANCAIS Pages 6/9  
 ENGLISH INDEX Pages 10/14  
 DEUTSCHES INHALTVERZEICHNIS Seiten 15/18

R E P E R T O I R E F R A N C A I S

A	Pages	C	Pages
Aiguilles	27	Canettes à huile	69
Allumettes	70	Canif	27
Ancres articulées	50	Carbolineum	77
Ancres " Danforth "	50	Ceintures de sauvetage	29
Ancres à Jas	50	Ceintures de sureté	28
Ancres de corps mort	51	Chaines en acier	51
Ancres flottantes	62	Chaines de Martinet	51
Anneaux sur plaque	49	Chaines pr. télégraphe	70
Anneaux plats	71	Chaise pr. gabier	33
Anneaux ronds	38	Champignons d'aération	71
Anti-corrosive peinture	76	Chanvre peigné	23
Anti-dérapante peinture	76	Charpentes pr. briques	78
Anti-salissante peinture	76	Chaumards	48
Attaches pr. télégraphe	70	Chiffons blancs	23
Avirons	63	Cire d'abeilles	27
		Ciseaux pr. mèches	65
B		Clef de manille	46
Bâches	35	Cloches	69
Bagues de foc	46	Clous de bateaux	60
Balais de coco	74	Coinceurs d'écoute	49
Ballons de défense	28	Coins de Cale	59
Barils de galère	62	Coins pr. échelles	33
Biscuits de mer en boîtes	63	Colliers de serrage	68
Bitord goudronné	22	Contre-poids	39
Bitume	77	Copperpaint	76
Bittes d'amarrage	48	Cordages Manille	19
Boîtes à biscuits	63	Cordages Chanvre	19
Bosses de chaîne	51	Cordages Coton	19
Bouchons de nable	64	Cordages Nylon	19
Bouées d'amarrage	51	Cordes filasse	23
Bouées de sauvetage	29	Cordes tressées	23
Boulons plongeurs	45	Cordonnets	22
Boussoles	73	Cornets de brûme	69
Briques de pont	78	Cosses pr. aussières	41
Brosses en acier	74	Cosses pr. câbles en acier	40
Brosses à épousseter	74	Cosses pr. cordage chanvre	40
Brosses à goudronner	74	Cosses en fonte	41
Brosses à recurer	74	Cosses rondes	41
Brosses à recurer à main	74	Coupe-cables	39
Brosses de rue	74	Coton à calfater	78
Burettes à huile	68	Couteaux de marin	27
Burins à calfat	78	Couteaux pr. coupe-cables	39
		Crapaudine pr. bouchons	64
C		Crochets C	26
Cabillots en bois	64	Crochets de chargement	38
Cables en acier	20/21	Crochets avec cosse	38
Cables de gréement	20	Crochets de halage	46
Cable " Springlay "	22	Crochets avec languette	46
		Crochets de palan	38
		Crochets à river	38



R E P E R T O I R E F R A N C A I S

C	Pages	F	Pages
Crochets de sauvetage	44	Fers à calfat	78
Crochets de voilier	27	Fers de gaffe	44
Cross à chaîne	52	Feutre pr. doublage	23
Croissants de poulie		Feutre gaufré	23
d'écoute	47	Feux bicolores	66
Cruches à huile	69	Feux de bouées	70
Cuillers à poisser	78	Feux de mouillage	66/67
		Feux de position	66/67
D		Feux de poupe	66/67
Dames de nage	45	Feux rouges	70
Danforth Ancres	50	Feux de signalisation	67
Déchets de coton	23	Feux de tête de mât	66/67
Dés de réas	60	Fibre de coco	23
Défenses	28	Ficelles	22
Dévernisseur	76	Filasses Corde	23
Disques pr. signaux	69	Filets de chargement	24
Doubles bittes	48	Fils d'amarrage	22
Douilles pr. câbles	41	Fils à voile	22
Douilles pr. dames de nage	45	Formflex	79/80
Drapeaux de pays	32	Fourches de perche	44
Drapeaux signaux	30	Frettes de mât	47
Drisses de pavillon	19	Fusées	70
		G	
E		Gaines pr. couteaux	27
Echelles en cordage	33	Gaffes	44
Echelles avec crochets	33	Garde-Rats	60
Echelons	33	Gauges	72
Ecopes	64	Girouettes	30
Ecubiers	49	Glissières de mât	47
Elingues	24/25	Gobelets	62
Email Blanc peinture	76	Goudrons	77
Emerillons pr. chaîne	52	Graisse animale	80
Emerillons pr. pavillons	33	Grappins	50
Enduit pr. bâches	80	Grattoirs	44
Entonnoirs	69		
Epissoirs	27	Guindeaux	51
Epuisettes	62		
Estropes	24/25	H	
Etamines de pavillon	31	Hachettes	64
Etoupes à calfater	78	Hublots fixes	71
Extincteurs	75	Hublots ouvrant	71
		Huile de poisson	80
F		Hydro	76
Fanaux pr. Yachts	67		
Fanions	30	J	
Ferrofix	77	Jerrycans	60
Ferrures de gui	47		

VLAAMS INHOUDSTABEL Blz. 1/5

ENGLISH INDEX Pages 10/14

DEUTSCHES INHALTVERZEICHNIS Seiten 15/18

R E P E R T O I R E F R A N C A I S

L	Pages	N	Pages
Lampes à cardan	65	Nables de canot	64
Lampes d'applique	65	Nables de pont	49
Lampes torche	65		
Lanternes d'applique	65	0	
Lanternes à boule	66		
Lanternes de route	65	Oeillets pitons	39
Lanternes tempête	65	Oeillets pr. bâches	75
Lignes de jet	19		
Lignes de jet flottantes	22	P	
Lignes de sonde	73		
Liquid Marine Glue	76	Pagaies	63
Livres de code	33	Paillassons	23
Lochs	73	Palans à engrenages droits	54
Louvres d'aération	70	Paumelles de voiliers	27
Lunettes en aluminium	44	Pavillons du code	30
Lusin	22	Pavillons nationaux	32
		Peintures	76
M		Perches	44
Maillets à calfater	78	Perles de mât	45
Mailloches à fourrer	27	Pétards	70
Maillons à 2 vis	52	Pieds de biche	75
Maillons à river	37	Pieds de bouc (brosses)	75
Maillons STOP	37	Pierres à briquer	78
Maillons pr. chaîne télégr.	70	Pitons à boucle de filière	64
Manches à air	71	Pitons à écrou	49
Manches pr. brosses	74	Pitons pr. dynamo	39
Manches pr. briques de pont	78	Plaques pr. dame de nage	45
Manches pr. vadrouille	75	Plombs de sonde	73
Manettes de moteur	72	Poignées en bois	64
Manilles d'affourche	37	Poix de Suède	77
Manilles en cuivre	46	Pommes de mât	45
Manilles droites	36	Pompes de canot	68
Manilles forme lyre	37	Pompes à huile	68
Manilles à tête fraisée	36	Pompes semi-rotatives	68
Manilles tordues	36	Pompes " Step on it "	68
Margouillots	49	Porte-hampe	47
Marine glues	76/77	Porte-mousquetons	46
Marteaux à piquer	44	Pots à poix	78
Mastic	77	Poulies en bois	59
Matrices pr. oeillets	75	Poulies pr. yachts	58
Mégaphones	69	Poulies pr. câble acier	52/55
Merlin	22	Poulies pr. cordage chanvre	56/59
Mètres rubans	72	Poulies coupées	55
Miroirs de signalisation	70	Poulies de martinet	54
Moteurs Hors Bord	81	Poulies de mâte de charge	54
Moufles pr. câbles acier	52/55	Poulies de renvoi	54
Moufles pr. cordage chanvre	56/59	Poulies galvanisés	57
Mousqueton à piston	46	Prélarts	35

VLAAMS INHOUDSTABEL Blz. 1/5

ENGLISH INDEX Pages 10/14

DEUTSCHES INHALTVERZEICHNIS Seiten 15/18

R E P E R T O I R E F R A N C A I S

Q	Pages	T	Pages
Quarantenier	19	Talurit Manchons	24
		Taquets	48
R		Tendeurs	42
Racloirs	44	Têtes de brosse à goudr.	74
Rails pr. glissières	47	Toiles	34/35
Réas pr. cables en acier	61	Torches	69
Réas pr. cordage en chanvre	60/61	Trêfles de chargement	54
Réceptifs à eau	62	Treuels d'ancre	51
Ridoirs	42/43	Treuels pr. cables acier	53
Ridoirs à levier	42	Treuels pr. ligne de sonde	73
Rocambeaux	47	Treuels muraux	56
Rondelles en cuivre	60	Tubes pr. cordage d'estrope	41
Roues de gouvernail	72	Tuyaux pr. pompe de canot	68
Rubans pr. ceintures	35		
Rubans mètres	72	U	
		Umea Goudron	77
S		V	
Sacs à cendres	28	Vadrouilles	75
Sacs à filer l'huile	62	Vernis noir	77
Sangles	35	Vernis pr. yacht	76
Sangle de chargement	25		
Seamflex	77		
Seaux galvanisés	68		
Serre-cables	42		
Signaux fumigènes	70		
Signaux parachutes	70		
Sonde Lignes de	73		
Sondes pliables	72		
Sonde Plombs de	73		
Spinglay	22		
Stop Maillons	37		

VLAAMS INHOUDSTABEL Blz. 1/5  
 ENGLISH INDEX Pages 10/14  
 DEUTSCHES INHALTVERZEICHNIS Seiten 15/18

E N G L I S H   I N D E X

A	Pages	B	Pages
Anchor lamps	66/67	Brushes	74
Anchors	50/51	Buckets	68
Anchors Sea-	62	Bulkhead Lamps	65
Anticorrosive Paints	76	Bulkhead Ventilators	70
Antifouling Paints	76	Bunting	31
Antislip Paints	76	Buoyant heaving Lines	22
Ashbags	28	Buoylights	70
Ashoars	63	Buoys Life-	29
		Buoys Mooring-	51
B		C	
Backlamps	65	Cablecutters	39
Bags Ash-	28	Cans	69
Bailers	64	Canvas	34/35
Bannister brushes	74	Carbolineum	77
Bass Brooms	74	Cardful hemp	23
Beads Parrel-	45	Cargoblocks	54
Beewax	27	Cargohooks	38
Bells	69	Cargonets	24
Belts Life-	28	Case Slings	26
Bicolour lamps	66	Cast iron thimbles	41
Biscuits in tins	63	Caulking Cotton	78
Biscuitcases	63	Caulking Irons	78
Bits	48	Caulking Mallets	78
Blackvarnish	77	Chainblocks	54
Blades for Cable Cutters	39	Chainhooks	52
Blocks Cargo	54	Chainpipes	49
Blocks Copper	57	Chains Cable-	51
Blocks Galvanized	57	Chainslings	26
Blocks Heel-	54	Chains Telegraph-	70
Blocks for Hemprope	56/59	Chainstoppers	51
Blocks for Steel Wire rope	52/55	Chainswivels	52
Blocks Snatch-	55	Chipping Goggles	44
Blocks Top Lift-	54	Chipping Hammers	44
Blocks Wood-	59	C Hooks	26
Blocks Yacht-	58	Clawrings	47
Boatbailers	64	Cleats	48
Boathooks	44	Cleats Jam-	49
Boatnails	60	Cliphooks	46
Boatplugs	64	Cloths	34/35
Boatpumps	68	Coaltar	77
Boatwain's Chair	33	Codebooks	33
Bollards	48	Codeflags	30
Braided rope	23	Counter poise	39
Brass eyelets	75	Coirbrooms	74
Breakers	62	Coirfibre	23
Broomhandles	74	Coirmats	23
Brooms	74		

VLAAMS INHOUDSTABEL Blz. 1/5  
 REPERTOIRE FRANCAIS Pages 6/9  
 DEUTSCHES INHALTVERZEICHNIS Seiten 15/18

E N G L I S H I N D E X

C	Pages	F	Pages
Compasses	73	Fixed Lights	71
Connecting links	37	Flaghalyard	19
Connecting Plates	52	Flags	30/32
Controllevers	72	Flagstaffsockets	47
Copper blocks	57	Flagswivels	33
Copperpaints	76	Flare-up	69
Copper roves	60	Flat rings	71
Copper shackles	46	Foghorns	69
Corkfenders	28	Folding Grapnels	50
Cotton Caulking	78	Frames for Deckstones	78
Cotton Duck	34	Funnels	69
Cotton ropes	19	Formflex	79/80
Cowls ventilating	71		
Crane Hooks	38	G	
Crowbars	75	Galvanized Blocks	57
		Galvanized Buckets	68
D		Galvanized Steel Wire rope	20/21
Danforth Anchors	50	Gauges Rope-	72
Deapsealeadline	73	Gears Reefing-	47
Deckscrews	49	Gimbal Lamps	65
Decksrubbers	74	Globe Lamps	66
Deck stones	78	Goblets	62
Dies for Cablecutters	39	Goggles Chipping-	44
Dippers Water-	62	Grapnels	50
Distress Signals	70	Grips Wire-	42
Double bits	48		
D Shackles	36	H	
Duck	34	Hairfelt	23
Dynamo bolts	39	Halyard Flag-	19
		Hammers Chipping-	44
E		Handleadlines	73
Enamel Paints	76	Handles Broom-	74
Engine Spun yarn	23	Handles Deckstone-	78
Extinguishers	75	Handles for lifeline	64
Eyebolts copper	49	Handles Mop-	75
Eyebolts steel	39	Handles Tarbrush-	74
Eyelets brass	75	Handscrubbers	74
Eyeplates	49	Harpshackles	37
		Hatchwedges	59
F		Hatchets	64
Fairleads	48/49	Hawser Thimbles	41
Feeders	68	Heartthimbles	40
Felts	23	Heavinglines	19
Fenders	28	Heavinglines Buoyant	22
Ferrofix	77	Heelblocks	54
Fire extinguishers	75	Hemp Cardful	23
Fish oil	80	Hemropes	19
		Hooks Cargo-	38
		Hooks Clip-	46
		Hooks Lifting-	38

VLAAMS INHOUDSTABEL Blz. 1/5  
 REPERTOIRE FRANCAIS Pages 6/9  
 DEUTSCHES INHALTVERZEICHNIS Seiten 15/18

E N G L I S H   I N D E X

H	Pages	M	Pages
Hooks Sail-	27	Manila ropes	19
Hooks Spring-	46	Marine Glue Pitch	77
Hooks Towing	46	Marine glues sundries	77/78
Hose clips	68	Marlin	22
Hoses Water-	68	Marlin Spikes	27
Houseline	22	Mastbands	47
Hurricane Lamps	65	Mastheads	66/67
Hydro Marine Glue	76	Masthead trucks	45
		Matches	70
I		Mats Coir	23
Intern. Code Flags	30	Megaphones	69
		Mirror signalling	70
J		Mooring Buoys	51
Jack Knives	27	Mooring Shackles	37
Jackets Life-	29	Mophandles	75
Jackettapes	35	Mops	75
Jamcleats	49	Mushroom ventilators	71
Jerrycans	80		
		N	
K		Nails Boat-	60
Knives	27	Needles	27
		Nets Cargo-	24
		Nylon Ropes	19
L		O	
Ladders Pilot-	33	Oakum	78
Lamps	65	Oars	63
Lamp Scissors	65	Oilbags	62
Leadline reels	73	Oilcans	69
Leadlines	73	Oilfeeders	68
Leads Sounding-	73	Oilfillers	69
Levers Control-	72	Oilpumps	68
Lifebelts	28	One Armed Anchors	51
Lifebuoylights	70	Oval eyes swivels	52
Lifebuoys	29	Outboard Motors	81
Lifejackets	29		
Life line ringbolts	64	P	
Lights fixed	71	Packingcloth	35
Lines heaving-	19	Packingneedles	27
Lines Lead-	73	Paddles	63
Lines Tape-	72	Paintremovers	76
Links	37	Paints	76
Liquid Marine Glue	76	Palms Sailor's	27
Logs	73	Parachute signals	70
		Parrelbeads	45
M		Pilotladders	33
Mallets Caulking-	78	Piston hanks	46
Mallets Serving-	27	Pitch	77

VLAAMS INHOUDSTABEL Blz.1/5  
 REPertoire FRANCAIS Pages 6/9  
 DEUTSCHES INHALTVERZEICHNIS Seiten 15/18

E N G L I S H I N D E X

P	Pages	S	Pages
Pitchladders	78	Seaman Sheets	27
Pitchpots	78	Seamflex	77
Plugs	64	Seizing Wire	22
Poopfenders	28	Semi rotary pumps	68
Portlights	71	Serving Mallets	27
Preventer Chains	51	Sewing twine	22
Pumps	68	Shackle keys	46
Punch & Dies	75	Shackles copper	46
		Shackles D	36
R		Shackles H	37
Rags	23	Shafts Boathook-	44
Ratguards	60	Shankhooks	38
Ratline	19	Sheating Felt	23
Redlights	70	Sheat's Seaman	27
Reefing gears	47	Sheavebushes	60
Reels Leadline	73	Sheaves for hemprope	60/61
Reels Steel wire rope	53	Sheaves for steel wire	61
Rigging screws	42/43	Shiplogs	73
Rigging wire ropes	20	Shootsignals	70
Ring bolts Life line	64	Sidelamps	66/67
Ringplates	49	Signal Distress	70
Rings Flat	71	Signal Flags	30
Rings Round	38	Signal Shapes	69
Rockets	70	Signalling mirrors	70
Rods	72	Slices	44
Rope Gouges	72	Slides	47
Ropeladders	33	Slings Chain-	26
Ropes	19	Slings Rope-	24/25
Ropeslings	24/25	Smokesignals	70
Ropesockets	41	Snapshackles	46
Ropes Steel wires	20/21	Snatchblocks	55
Round Thimbles	41	Sockets Flagstaff-	47
Roves Copper	60	Sockets Rowlock-	45
Rowlockplates	45	Sockets for wire rope	41
Rowlocks	45	Sounding Leads	73
Rowlocksockets	45	Sounding rods	72
Rubber Hoses	68	Spikes Marline	27
		Springhooks	46
S		Springlay	22
Sailcloth	35	Spunyarn	22/23
Sailhanks	46	Spur Gear Chain blocks	54
Sailhooks	27	Steel wire rope blocks	52/55
Sailneedles	27	Steel wire ropes	20/21
Sailor's Palms	27	Steering wheels	72
Sailtwine	22	Stemfenders	28
Scissors Lamp-	65	Step on it pumps	68
Scrapers	44	Steps	33
Scrubbers	74	Sternlamps	66/67
Seaanchors	62	Stockanchors	50
Seaman knives	27	Stockless anchors	50
		Stones Deck-	78
		Stoplincs	37

VLAAMS INHOUDSTABEL Blz.1/5  
 REPERTOIRE FRANCAIS Pages 6/9  
 DEUTSCHES INHALTVERZEICHNIS Seiten 15/18

E N G L I S H I N D E X

S	Pages	W	Pages
Straining Screws	42	Watertanks	62
Swedish Pitch	77	Wedges Hatch-	59
Swedish Tar	77	Winches Wall-	56
Swivels Chain-	52	Winches Wire-	53
Swivels Flag-	33	Windlasses	51
Swivel Snap Shackles	46	Windvane	30
		Wire Brushes	74
T		Wire Grips	42
Tackle Hooks	38	Wire Rope Blocks	52/55
Tallow	80	Wire Ropes	20/21
Talurit	24	Wire Rope Sockets	41
Tapes for Jackets	35	Wire Seizing	22
Tapelines	72	Wire Winches	53
Tar	77	Wood Blocks	59
Tarbrushes	74		
Tarbrushes with handle	75	Y	
Tarpaulin Canvas	35	Yachtblocks	58
Tarpaulins	35	Yachtduck	34
Telegraph chains	70	Yachtenamel	76
Terminals	70	Yachtfenders	28
Thimbles	40/41	Yachtlamps	67
Toggles for Painters	64	Yachtvarnish	76
Toplift Blocks	54		
Torchlamps	65		
Towing Hooks	46		
Track for slides	47		
Travellers	47		
Trucks Masthead-	45		
Turnover rowlocks	45		
Twines	22		
U			
Umea Tar	77		
Union Plates	54		
V			
Varnish Black-	77		
Varnish Yacht-	76		
Ventilating Cows	71		
Ventilators	70		
W			
Wallwinches	56		
Waste	23		
Waterbreakers	62		
Waterdippers	62		
Waterhoses	68		

VLAAMS INHOUDSTABEL Blz.1/5  
 REPertoire FRANCAIS Pages 6/9  
 DEUTSCHES INHALTVERZEICHNIS Seiten 15/18



D E U T S C H E S    I N H A L T V E R Z E I C H N I S

A	Seiten	B	Seiten
Anker Danforth	50	Bürste Scheuer-	74
Anker Klapp-	50	Bürste Stahl-	74
Anker See-	62	Bürste Stiel-	74
Anker Stock	50		
Ankerlaternen	66/67	C	
Ankerspille	51		
Anlegeringe	49	C Haken	26
Antiglitschfarbe	76	Codebücher	33
Anwuchschutzfarbe	76	Codeflaggen	30
Aschensäcke	28	Copperpaint	76
Augbolze	39/49		
Ausholring	47	D	
Auslösapparat	75		
Aussenbord Motoren	81	Danforth Anker	50
		Deckverschraubungen	49
B		Doppelkreuzpoller	48
Bahia Besen	74	Draggen Falt-	50
Balancierlampe	65	Draggen mit Pallen	50
Ball Signal-	69	Draggen mit Spitzen	50
Band für Rettungsgurtel	35	Draht Bindsel-	22
Bande Top-	47	Drahtseil	20/21
Bänder Sicherheit-	28	Drahtseilblöcke	52/55
Baumwollen Tau-	19	Drahtseilkauschen	40
Baumwollen Tuch	34	Drahtseilklemmen	42
Becher Graduierte	62	Drahtseil Rostfreie	21
Beile	64	Drahtseilscheiben	61
Belegklampen	48	Drahtseilschneider	39
Besen Bahia	74	Drahtseilwinde	53
Besen Lappen	75	Drehbare Leiter	33
Bienenwachs	27	D Schakel	36
Bindgarn	22	E	
Bindsel Draht-	22		
Blanke Drahtseil	20	Eichstäbe	72
Blockchen Messing	57	Eimer	68
Blöcke Drahtseil	52/55	Entlüfter	71
Blöcke Fuss-	55	Entlüftungsrosette	70
Blöcke Hanfseil	56/59		
Blöcke Holz-	59	F	
Blöcke Verzinkte	57		
Blöcke Yacht-	58	Fackel	69
Bojen Rettungs-	29	Fallschirmsignale	70
Bojen Rettungslicht-	70	Faltdraggen	50
Bojen Vertau-	51	Farbe Antiglitsch	76
Bolze Aug-	39/49	Farbe Anwuchschutz	76
Bombay Hanftau	19	Farbe Rostschutz	76
Bootmannstuhl	33	Fässcher Wasser	62
Bootshaken	44	Federreffer	47
Bootsnägel	60	Fender	28
Bücher Code-	33	Fensterringe	71
Bürste Handscheuer	74	Ferrofix	77
Bürste Koko-	74	Fett Tierisches	80

VLAAMS INHOUDSTABEL Blz.1/5  
 REPERTOIRE FRANCAIS Pages 6/9  
 ENGLISH INDEX Pages 10/14

DEUTSCHES INHALTVERZEICHNIS

F	Seiten	H	Seiten
Filz	23	Holzblöcke	59
Firnis Yacht-	76	Holzkeile	59
Fischöl	80	Holzpech	77
Flache Ringen	71	Hüsing	22
Flaggen Intern. Code-	30	Hydro Marine Glue	76
Flaggen Ländern-	30/32		
Flaggenknopf	45	I	
Flaggen Signale-	30		
Flaggen stockhalter	47	Intern. Codeflaggen	30
Flaggentuch	31	Italienische Hanftau	19
Flaggenwirbel	33		
Flaschenzüge	54	J	
Fockschäkel	46		
Formflex	79/80	Jerrycans	80
Fussblöcke	55		
		K	
G			
Gabbeln Rudder-	45	Kajutfenster	71
Gasregler	72	Kalfatbaumwolle	78
Geflochten Tau	23	Kalfateisen	78
Gegengewicht	39	Kalfathammer	78
Gehechelter Hanf	23	Kanne Öl-	69
Glocken	69	Kanne Schmier-	68
Graduierte Becker	62	Karabinerhaken	46
Griffe Holze	64	Kauschen Drahtseil-	40
Gürtel Rettungs-	29	Kauschen gusseiserne	41
Gusseiserne Kauschen	41	Kauschen Hanfseil-	40
		Kauschen Runde	41
		Kauschen Trossen	41
H		Keile Holz-	59
Haarfilz	23	Ketten	51
Haken Boots-	44	Kettenhaken	52
Haken Karabiner-	46	Ketten Hanger-	51
Haken Ketten-	52	Kettenklüsen	49
Haken Klipp-	46	Kettenstopper	51
Haken Lade- mit öse	38	Kettenstropps	26
Haken Lade- mit Zapfen	38	Kettenverbindungsglieder	37
Haken Segel-	27	Kettenwirbel	52
Haken Talje-	38	Kistenstropps	26
Halb rotation Pumpe	68	Klampen Beleg-	48
Hammer Pick-	44	Klappanker	50
Handplatten	27	Kleidkeulen	27
Handscheuerbürste	74	Klemmen Drahtseil-	42
Hanfseilblöcke	56/59	Klemmen Schlauch-	68
Hanfseilkauschen	40	Klipphaken	46
Hanftauscheiben	60/61	Klüsen Ketten-	48
Hangerblöcke	54	Knallsignale	70
Hangerketten	51	Knopf flaggen-	45
Hangerplatten	54	Koffeinägel	64
Hecklaternen	66/67	Kokobürste	74
Hinterfender	28	Kokofasern	23
		Kokosmatten	23

VLAAMS INHOUDSTABEL Blz.1/5  
 REPERTOIRE FRANCAIS Pages 6/9  
 ENGLISH INDEX Pages 10/14

D E U T S C H E S    I N H A L T V E R Z E I C H N I S

K	Seiten	M	Seiten
Kompass	73	Messing Schäkel	46
Kopfender	28	Motoren Aussenbord	81
Kugellaterne	66		
Kuhfuss	75	N	
<b>L</b>		Nadeln	27
Lack Yacht-	76	Nägel Boots-	60
Ladeblöcke	54	Nebelhorn	69
Ladehaken	38	Netze Lade-	24
Ladenetze	24	O	
Lampe Balancier-	65	Öle Fisch-	80
Lampe Wand-	65	Ölkanne	69
Lampenschere	65	Ölpumpe	68
Lappenbesen	75	Ölsacke	62
Lappenbesenstiel	75	Ösfasser	64
Lasthaken	38		
Laterne Anker-	66/67		
Laterne Heck-	66/67	P	
Laterne Kugel-	66	Paddel	63
Laterne Positions-	66/67	Pech	77
Laterne Sturm-	65	Pechlöffel	78
Laterne Top-	66/67	Pechtopf	78
Laterne Wand-	65	Peillot	73
Laterne Yacht-	67	Pickhammer	44
Leckschrauben	64	Platten-Hand-	27
Leim Textiel-	80	Platten Hanger-	33
Leine Lot-	73	Platten Strops-	26
Leitblöcke	54	Plumpen Wasser-	62
Leiter Drehbare	33	Poller	48
Leiter Tau-	33	Positionslaterne	66/67
Liquid Marine Glue	76	Pumpe Halb Rotation	68
Löffel Pech-	78	Pumpe Messing	68
Log Schiffs-	73	Pumpe Öl-	68
Lotleine	73	Pumpe Step on it	68
Lotrolle	73	Presenningen	35
Lumpen	23	Presenningtuch	35
<b>M</b>		<b>R</b>	
Manila Tau	19	Raketten	70
Marine Glue	77	Rattenschirme	60
Marleine	22	Rauchsignale	70
Marlspieker	27	Reffer Feder-	47
Mastrutscher	47	Rettungsbojen	29
Mastschiene	47	Rettungsbojenlicht	70
Matrize Segelkauschen	75	Rettungsgürtel	29
Matten Kokos-	23	Rettungshaken	44
Messer Drahtseilschneider	39	Riemen	63
Messer Seeman-	27	Ringbolzen für Griffleinen	64
Messer Yacht-	27	Ringe	38
Messing Blockchen	57		

VLAAMS INHOUDSTABEL Blz.1/5  
 REPERTOIRE FRANCAIS Pages 6/9  
 ENGLISH INDEX Pages 10/14

D E U T S C H E S      I N H A L T V E R Z E I C H N I S

R	Seiten	S	Seiten
Ringe Flache	71	Seeanker	62
Ringe mit Platte	49	Seemannsmesser	27
Ringschrauben	39	Segelgarn	22
Rollbandmasse	72	Segelhaken	27
Rostfrei Drahtseil	21	Segelkausche	75
Rostfreie Spannschrauben	42	Segelnadeln	27
Rostschutzfarbe	76	Segeltuch	35
Roststecher	44	Seil Draht-	20/21
Rotfeuern	70	Seilhulsen	41
Ruddergabeln	45	Seilklemmen	42
Ruddergabelbuchsen	45	Seitenlaternen	66/67
Ruddergabelplatten	45	Sicherheitsbänder	28
Runde Kauschen	41	Signalball	69
		Signale Fallschirm-	70
S		Signale Flaggen	30
Säcke Aschen-	28	Signale Rauch-	70
Säcke Öl-	62	Signale Rotfeuern	70
Sacknadeln	27	Signalspiegel	70
Schäkel D	36	Spannschrauben	42/43
Schäkel Geschweiste	37	Spannschlösser	42
Schäkel Foch-	46	Spille Anker-	51
Schäkel für Ladebaume	36	Sprachrohr	69
Schäkel Messing	46	Springlaytau	22
Schäkel mit bolzen	36	Stagreiter	46
Schäkel mit Schlitbolzen	36	Stahlbürste	74
Schäkel mit 2 Schrauben	52	Stahldrahtseil	20/21
Schäkelöffner	46	Step on it Pumpe	68
Schäkel verdrehte	36	Steuerrad	72
Schäkel Vertau-	37	Stockanker	50
Scheibebüchsen	60	Stopper Ketten-	51
Scheiben Hanftau-	60/61	Streichhölzen	70
Scheiben Drahtseil-	61	Stropps Tau-	24/25
Scheibchen Kupfere	60	Stropps Ketten-	26
Scheide Seemannmeser-	27	Stuhl Bootmanns-	33
Schere Lampen-	65	Sturmlaterne	65
Scheuerbürste	74		
Scheuersteine	78	T	
Schiemansgarn	22	Taljihaken	38
Schiffsfilz	23	Talurit	24
Schiffsflag	30/32	Tanks Wasser-	62
Schiffslog	73	Tanks Zwieback-	63
Schiffswerg	78	Tau	19
Schlauch	68	Tau Springlay	22
Schlauchklemme	68	Tauleiter	33
Schlepphaken	46	Taustropps	24/25
Schlösser Spann-	42	Teer	77
Schmierkanne	68	Teerkopf	74
Schothalter	49	Teerkopf mit stiel	75
Schotleitösen	49	Teerkopfstiel	74
Schotringe	47	Telegrafkette	70
Seamflex	77	Tierisches Fett	80

VLAAMS INHOUDSTABEL Blz.1/5  
 REPERTOIRE FRANCAIS Pages 6/9  
 ENGLISH INDEX Pages 10/14

D E U T S C H E S    I N H A L T V E R Z E I C H N I S

T	Seiten		Y - Z	Seiten
Toppbände	47		Yachtblöcke	58
Topplaterne	66/67		Yachtfender	28
Treibende Wurleine	22		Yachtfirnis	76
Trichter	69		Yachtlack	76
Tritte für Tauleiter	33		Yachtlampen	67
Tuch Baumwollen-	34		Yachtmesser	27
Tüch Flaggen-	31		Yachttuck	34
Tuch Presenning-	35		Zahnradflaschenzuge	54
Tuch Segel-	35		Zweilichtlaternen	66
Twist	23		Zwiebacktanks	63
U				
Umea teer'	77			
Untermesser	39			
V				
Verbindungsglieder Ketten-	37			
Verdrehte Schäkkel	36			
Verklicker	30			
Versailtes Tau	23			
Vertaubojen	51			
Vertauschäkkel	37			
Verzinkte blöcke	57			
Verzinkte Drahtseil	20/21			
W				
Wachs	27			
Wandlampe	65			
Wandlaterne	65			
Wandwinden	56			
Wasserfässchen	62			
Wasserplumpen	62			
Wasserpumpen	68			
Wassertanks	62			
Werg Schiffs-	78			
Winden Drahtseil-	53			
Windhuze	71			
Wirbel Flaggen-	33			
Wirbel Ketten-	52			
Wurfleine Treibende	22			

VLAAMS INHOUDSTABEL blz. 1/5  
 REPertoire FRANCAIS Pages 6/9  
 ENGLISH INDEX Pages 10/14

TEXTIELTOUWWERK

CORDAGES EN TEXTILES

TEXTILE ROPES

TEXTIL TAUWERK

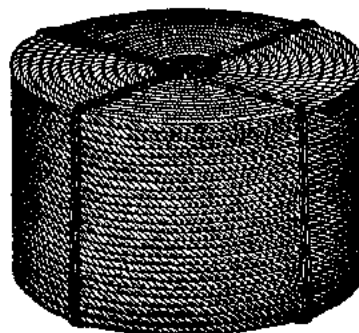

Prijzen per Kg.

		Doormeters in mm.						
		12 &+	10	8	7	6	5	4
n°905	MANILA Handel	per rol						
		met minder						
n°906	MANILA Prima	per rol						
		met minder						
n°907	MANILA Yacht.	per rol						
		met minder						
n°910	BOMBAY	per rol						
		met minder						
n°915	ITALIAANS	per rol						
		met minder						
n°920	KATOEN	per rol						
		met minder						
n°922	NYLON	per rol						
		met minder						

Technische gegevens van het kemptouwwerk 3 streng

Doormeters in mm.	4	5	6	7	8	10	12	14
Omtrek in duimen	1/2	5/8	3/4	7/8	1	1.1/4	1.1/2	1.3/4
per % meters + Kg.	1,6	2	2,8	4	4,8	6,5	8,8	11,9
+ meters per Kg.	62	50	36	25	21	15	11	8,4
Breekkracht Kg.								
Manila Prima					355	550	800	1100
Manila Yacht.					400	620	900	1235
Nylon		406	565		890	1375	2000	2750
Doormeters in mm.	16	18	20	22	25	28	32	36
Omtrek in duimen	2	2.1/4	2.1/2	2.3/4	3	3.1/2	4	4.1/2
per % meters + Kg.	15,6	19,8	24,4	29,5	38,1	47,8	62,5	79
+ meters per Kg.	6,4	5	4,1	3,4	2,6	2,1	1,6	1,3
Breekkracht Kg.								
Manila Prima	1500	1950	2425	3000	3940	4870	6245	7780
Manila Yacht.	1690	2195						
Nylon	3750	4800						

Prijzen opgesteld den

ZONDER VERBINTENIS

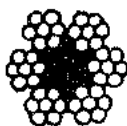

Gegalvaniseerd Samenstelling  
6 x 7 garens en 1 kempen ziel

Prijzen per meter

N° 607

Doormeters in mm.	3	4	5	6	7	8	10	12	14	16
Omtrek in duimen	3/8	1/2	5/8	3/4	7/8	1	1 1/4	1 1/2	1 3/4	2
per meter Kg.	0,034	0,06	0,09	0,13	0,17	0,22	0,33	0,51	0,68	0,87
Breekkracht Kg.	412	810	1210	1690	2255	2895	4415	6680	8990	7300
per % meters										
met minder										
Doormeters in mm.	18	20	22	24	28	32	36	40		
Omtrek in duimen	2 1/4	2 1/2	2 3/4	3	3 1/2	4	4 1/2	5		
per meter Kg.	1,09	1,46	1,74	2,03	2,70	3,40	4,28	5,45		
Breekkracht Kg.	9120	11180	14500	17060	22700	29170	36400	44500		
per % meters										
met minder										



Gegalvaniseerd Samenstelling  
6 x 37 garens en 1 kempen ziel

Prijzen per meter

N° 637 G

Doormeters in mm.	8	10	12	14	16	18	20
Omtrek in duimen	1	1 1/4	1 1/2	1 3/4	2	2 1/4	2 1/2
per meter Kg.	0,22	0,32	0,48	0,66	0,88	1,14	1,47
Breekkracht Kg.	2600	3800	5700	7900	10500	13600	17250
per % meters							
met minder							



B L A N K  
Prijzen per meter

N° 637 B

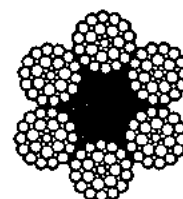

Doormeters in mm.	8	10
Omtrek in duimen	1	1 1/4
Samenstelling	6 x 37	
per meter Kg.	0,22	0,32
Breekkracht Kg.	3600	5300
per % meters		
met minder		

12	14	16	18
1 1/2	1 3/4	2	2 1/4
6 x 36 S W C			
0,57	0,74	0,94	1,16
8900	11700	14700	18300

Prijzen opgesteld den

ZONDER VERBINTENIS

STAALDRAADKABELS - CABLES EN ACIER - STEEL WIRE ROPES - STAALDRAHTSEIL



Gegalvaniseerd Samenstelling  
6x9 & 6x12 garens en  
7 kempe zielen  
Prijzen per meter

Doormeters in mm.	2	3	4	5	6	7	8	10
Omtrek in duimen	$\frac{1}{4}$	$\frac{3}{8}$	$\frac{1}{2}$	$\frac{5}{8}$	$\frac{3}{4}$	$\frac{7}{8}$	1	$1\frac{1}{4}$
Samenstelling	6x9	6x9	6x9	6x12	6x12	6x12	6x12	6x12
per meter Kg.	0,017	0,026	0,045	0,064	0,094	0,12	0,15	0,25
Breekkracht Kg.	195	300	595	775	1120	1400	1680	2900
per % meters Fr								
met minder Fr								



Gegalvaniseerd Samenstelling  
6 x 15 garens en 7 kempe zielen

	Prijzen per meter						
Doormeters in mm.	12	14	16	18	20	22	
Omtrek in duimen	$1\frac{1}{2}$	$1\frac{3}{4}$	2	$2\frac{1}{4}$	$2\frac{1}{2}$	$2\frac{3}{4}$	
per meter Kg.	0,33	0,44	0,565	0,705	0,860	1,035	
Breekkracht Kg.	3650	4860	6170	7760	9450	11400	
per % meters Fr							
met minder Fr							



Gegalvaniseerd Samenstelling  
6 x 24 garens en 7 kempe zielen  
Prijzen per meter

Doormeters in mm.	8	10	12	14	16	18	20
Omtrek in duimen	1	$1\frac{1}{4}$	$1\frac{1}{2}$	$1\frac{3}{4}$	2	$2\frac{1}{4}$	$2\frac{1}{2}$
per meter Kg.	0,22	0,33	0,46	0,61	0,785	0,98	1,195
Breekkracht Kg.	2650	3890	5480	7330	9370	11750	14320
per % meters Fr							
met minder Fr							
Doormeters in mm.	22	24	26	28	30	32	36
Omtrek in duimen	$2\frac{3}{4}$	3	$3\frac{1}{4}$	$3\frac{1}{2}$	$3\frac{3}{4}$	4	$4\frac{1}{2}$
per meter Kg.	1,43	1,83	2,12	2,435	2,77	3,125	3,905
Breekkracht Kg.	17240	21900	25450	29260	33240	37570	47000
per % meters Fr							
met minder Fr							

R O E S T V R I J

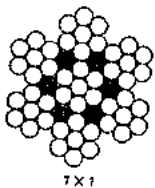

Doorm. mm.	3	4	5	6	3	4	5	6
Samenstel.	7x7	7x7	7x7	7x7	7x19	7x19	7x19	7x19
meter gr.	34	58	95	133	38	58	88	156
Breekkr. Kg.	580	1000	1335	2134	610	990	1450	2550
meter Fr								

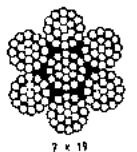

Prijzen opgesteld den

ZONDER VERBINTENIS





n°700 IJZERE BENSELLIJN - FIL D'AMARRAGE - SEIZING WIRE  
BINDSEL DRAHT

Doormeters in mm.	1½	2	2½	3	4
Rol van Kg. 5 Kg. Fr					



n°710 TIRKABEL - CABLE TIR  
Stale kabel Ø 3 mm. bedekt van doorschijnend  
plastiek Ø 8 mm.

de meter Fr  
eindstukken vr. dito het paar Fr



n°811 SPRINGLAY

Doormeters in mm.	20	24		
per meter Kg.	0,65	1.-		
Breekkracht Kg.	7300	8200		
per meter Fr				

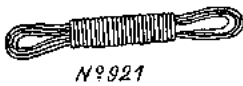

n°921 DRIJVENDE WERPLIJNEN - LIGNES DE JET FLOTTANTES  
BUOYANT HEAVING LINES - TREIBENDE WURFLEINE

Lengte 18 meters x Ø 8 mm. stuk Fr

n°1005 ZEILGAREN - FILS A VOILE - SAILTWINE - SEGELGARN  
2 & 3 draad in bollen van 200 gr.  
per Kg. Fr per bol Fr



n°1020 MARLIN - LUSIN - HOUSELINE - MARLEINE  
2 draad in bollen van Kg. 1 per bol Fr

HUISING - MERLIN - MARLIN - HUSING  
3 draad in bollen van Kg. 1 per bol Fr

n°1015 SCHIEMANSGAREN - BITORD GOUDRONNE - SPUNYARN  
SCHIEMANNSGARN  
in bollen van Kg. 5 per Kg. Fr

n°1010 BINDGAREN - FICELLES - TWINES - BINDGARN  
in kemp

Ø in mm. ±	1½	2	2½	3
Nummer	24/3	12/3	9/3	5/3
Bollen van Kg.	0,1	0,5	0,5	0,5
per bol Fr				

in sisal bollen van Kg. 1

Ø in mm.	2	4
Nummer	8/2	4/3
per bol Fr		

n°1012 KORDEELEN - CORDONNETS in Ital. Kemp

Ø in mm. ±	1½	2	2½	3	4
Nummer	36/6	24/6	24/9	15/9	12/12
Bollen van Kg.	0,1	0,2	0,2	0,2	0,5
per bol Fr					

Prijzen opgesteld den ZONDER VERBINTENIS

GEVLOCHTEN TOUW - CORDAGE TRESSE  
BRAIDED ROPE - VERSAILTES TAU



	6	8	10	12	14	16
Doormeter in mm.	6	8	10	12	14	16
+ Kg. per % meters	2	4,2	6	7½	9	17
+ meters per Kg.	50	24	17	13	11	6
n°925 Katoen het Kg. Fr						
n°926 Nylon het Kg. Fr						
n°940 Ital. Kemp Kg. Fr						



- n°951 FILASKOORD - CORDE FILASSE - ENGINE SPUNYARN  
in rollen van Kg. 5 het Kg. Fr
- n°1110 GEKAARDE KEMP - CHANVRE PEIGNE - CARDFUL HEMP  
GEHECHELTER HANF  
het popje van 100 gr. st. Fr  
per Kg. genomen het Kg. Fr
- n°1105 POETSKATOEN - DECHETS DE COTON - WASTE - TWIST  
in balen van 50 Kg.  
per kwantum van Kg. 50 10 1  
wit per Kg. Fr  
gekleurd per Kg. Fr

- n°1107 WITTE GEWASTE VODDEN - CHIFFONS BLANCS LAVES  
WHITE RAGS - WEISSE GEWASCHTE LUMPEN  
per kwantum van Kg. 50 10 1  
per Kg. Fr

- n°1100 COCOVEZELS - FIBRE DE COCO - COIRFIBRE  
KOKOSFASERN  
per baal van Kg. 50 het Kg. Fr  
minder als een baal het Kg. Fr



- n°1205 SCHEEPSVILT - FEUTRE pr. DOUBLAGE  
SHEATING FELT - SCHIFFSFILZ  
rollen van 20 x 1 meter de rol Fr  
met minder als een rol de meter Fr
- n°1210 HAARVILT - FEUTRE SEC GAUFRE - HAIRFELT  
HAARFILZ  
blad van 90 x 50 cm. het blad Fr
- n°1040 COCOMATTEN - PAILLASSONS EN COCO - COIRMATS  
KOKOSMATTEN  
van 35 x 60 cm. het stuk Fr

Prijzen opgesteld den ZONDER VERBINTENIS

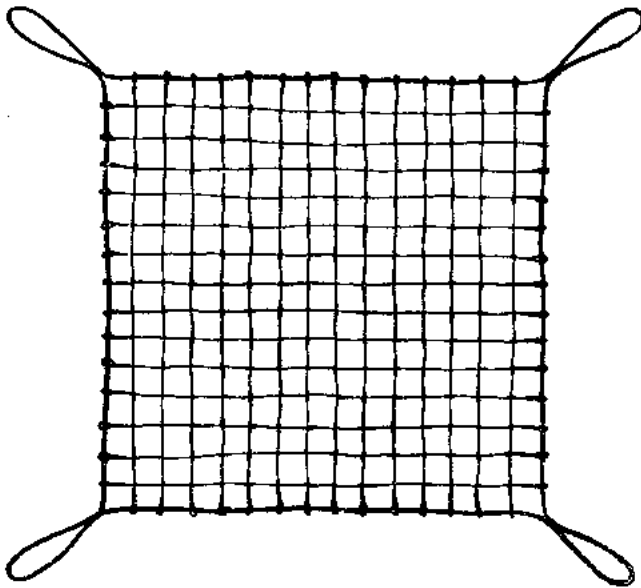

LAADNETTEN  
 FILETS DE CHARGEMENT  
 CARGONETS - LADENETZE

n°805 in staaldraadtouw  
 afmetingen 3M.50 x 3M.50  
 mazen van 25 x 25 cm.  
 stuk Fr

n°806 in Manila touw  
 afmetingen 3M.50 x 3M.50  
 mazen van 25 x 25 cm.  
 stuk Fr

TOUWSTROPFEN - ELINGUES EN FILINS  
 ROPESLINGS - TAUSTROPFS

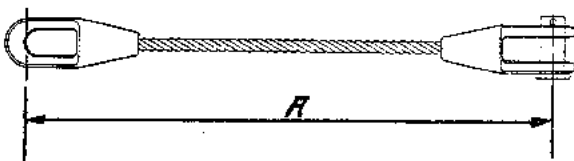
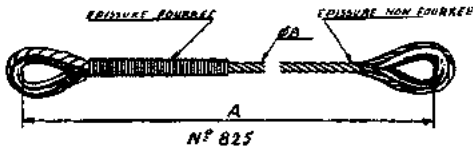
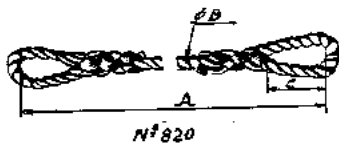
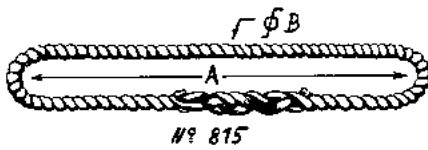

STAALDRAADTOUW met KABELSOCKETS  
 CABLES en ACIER avec DOUILLES

Prijzen opgesteld den

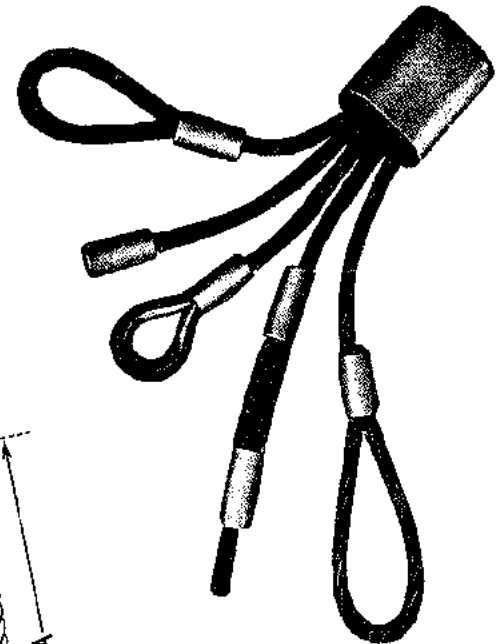

TALURIT

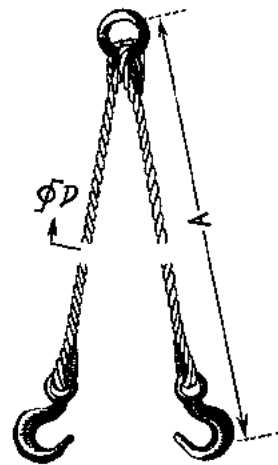

ZONDER VERBINTENIS

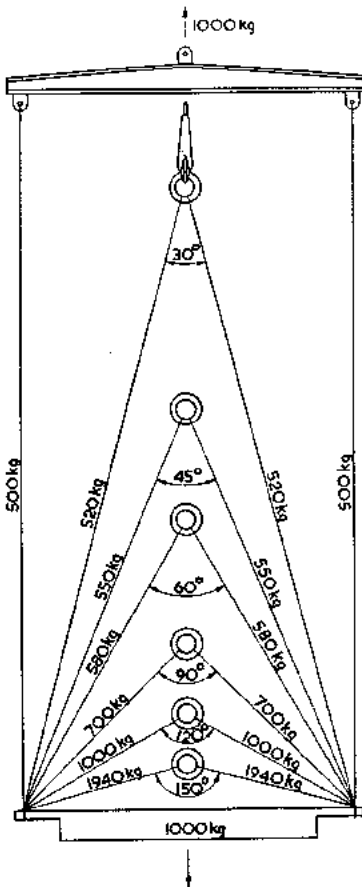

Werkbelasting van stropen, lengen, etc.

Werkbelasting WB	Wijze van aanslaan
1 x WB enkel part	<p>Leng      Strop      Twee-sprong</p>
1,5 x WB enkel part	<p>Dubbele leng      Eindloze strop      Drie-sprong</p>
2 x WB enkel part	<p>Vier-sprong</p>
1,5 x 1,5 = 2,25 x WB enkel part	<p>Eindloze strop      2 Dubbele lengen of -stropen</p>

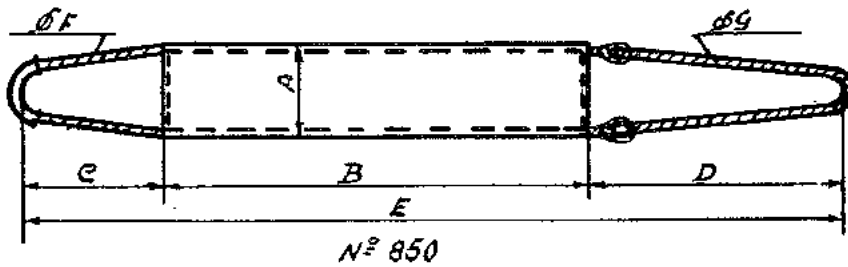

n°860 BROEKSTROPPIEN - ELINGUES à SACS  
in Manilatouw of staaldraadtouw

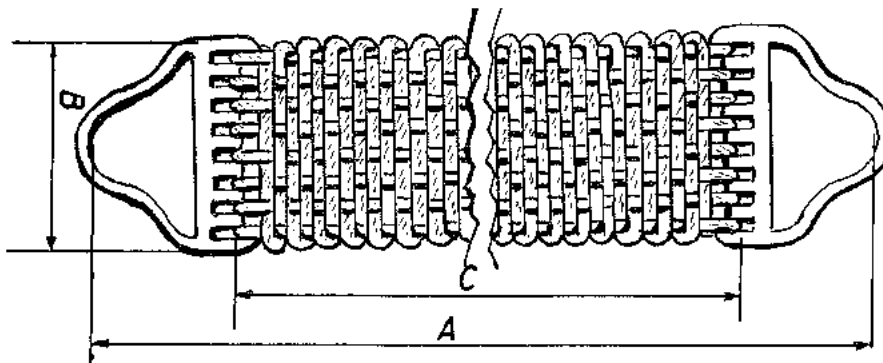

n° 865

n°865 LAADSANGEL - SANGLE DE CHARGEMENT  
in Manilatouw

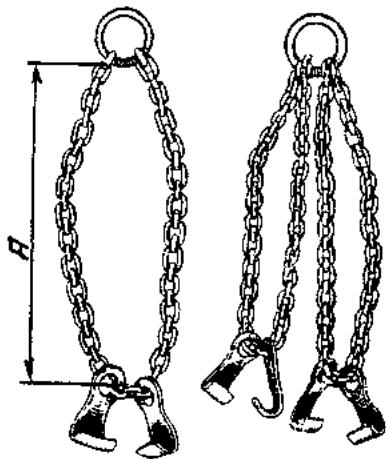

N°2921

N°2922

KETTINGLENGEN vr. VATEN  
 ELINGUES pr. FUTS  
 CHAINSLINGS for BARRELS  
 KETTENSTROPES für FÄSSER  
 n°2921 Enkel n°2922 dubbel

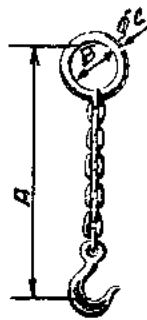

N°2941



N°2942

KETTINGLENGEN met HAAK & RING  
 ELINGUES à ANNEAU et CROCHET  
 CHAINSLINGS with HOOK & RING  
 KETTENSTROPES mit HAKEN & RINGEN  
 n°2941 enkel n°2942 dubbel

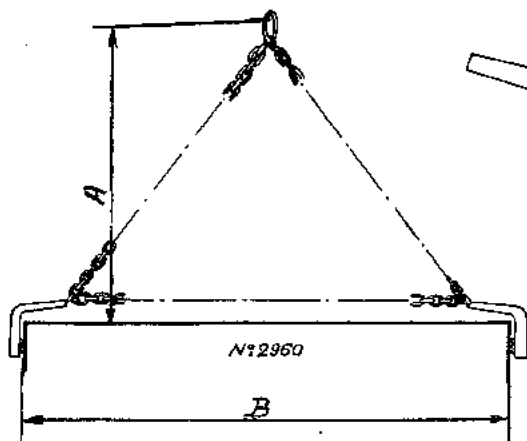

n°2960

KISTENLENGEN  
 ELINGUES pr. CAISSES  
 CASE SLINGS  
 KISTESTROPES

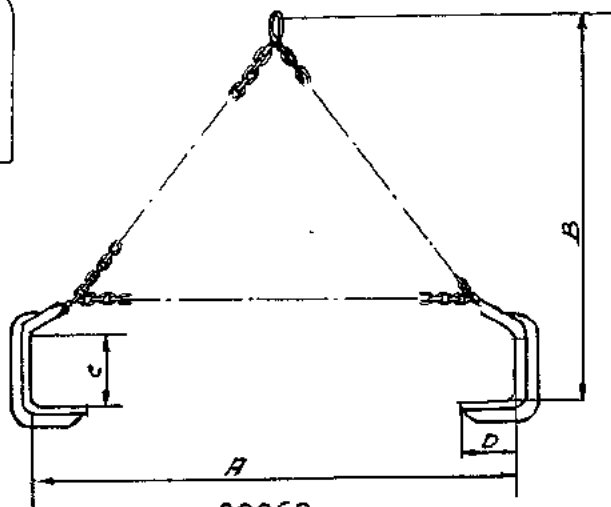
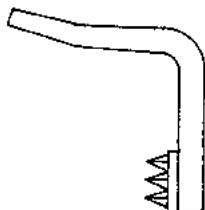

n°2962

PLATENLENG - ELINGUES pr. TOLES  
 SHEETIRONSLINGS - PLATTENSTROPES

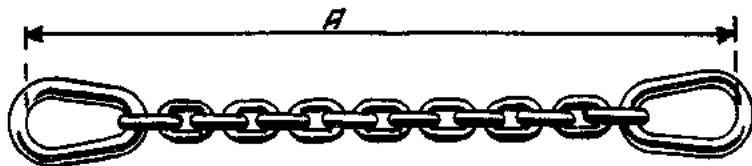

N°2931

n°2931 KETTINGLENG met DOORSCHUIVENDE RINGEN  
 ELINGUE avec ANNEAUX INTERCOULISSANTS  
 REEVABLE COLLAR SLINGS  
 KETTENSTROPPE mit HINDURCHSCHIENDEN RINGEN

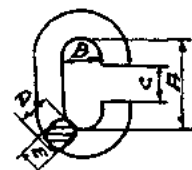

n°2119

C HAKEN - CROCHETS  
 C HOOKS - C HAKEN

n°1120 ZEILNAALDEN - AIGUILLES A VOILE - SAILNEEDLES - SEGELNADELN  
in pakken van 25 stuks

Nummer	16	15	14½	14	13	12	11	10	9
Lengte mm.	60	64	67	70	76	83	89	95	100
het pak Fr									
stuk Fr									

n°1121 ZAKNAALDEN - AIGUILLES A SAC - PACKING NEEDLES - SACKNADELN

 lengte 127 mm. stuk Fr



HANDPALMEN - PAUMELLES DE VOILIER  
SAILOR'S PALMS - HANDPLATTEN

n°1125 Engels model st. Fr

n°1126 Hollands model st. Fr

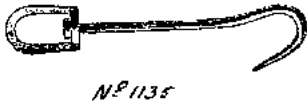

n°1135 ZEILHAKEN - CROCHETS DE VOILIER  
SAILHOOKS - SEGELHAKEN  
stuk Fr

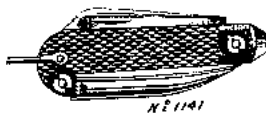

n°1141 SCOUTSMES - CANIF SCOUT  
JACK KNIFES - YACHTMESSER  
1 lemmer - 1 doosopener  
1 schroevendraaier - 1 splitspriet  
stuk Fr



n°1145 ZEEMANSMESSEN - COUTEAUX DE MARIN  
SEAMAN KNIFES - SEEMANNMESSER  
stuk Fr



n°1150 SCHEDEN vr. ZEEMANSMESSEN - GAINES  
pr. COUTEAUX DE MARIN - SEAMAN'S  
SHEATS - SCHEIDE für SEEMANNMESSER  
stuk Fr

SPLITSPRIEMEN - EPISSOIRS - MARLINE SPIKES - MARLSPIEKER



lengte in cm.	15	20	25	30	35	40	46	51	61
lengte in duimen	6	8	10	12	14	16	18	20	24
n°2020 gansch in staal									
n°2025 staal m/handvat									
n°2030 in hout									

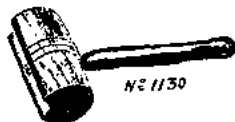

n°1130 KLEEHAMERS - MAILLOCHES A FOURRER  
SERVING MALLETS - KLEIDKEULEN  
stuk Fr

n°1131 BIEENWAS - CIRE D'ABELLES - BEEWAX - BIENEWACHS  
het Kg. Fr

Prijzen opgesteld den

ZONDER VERBINTENIS



N<sup>o</sup> 1220

n<sup>o</sup>1220 AANVAARZAKKEN - BALLONS DE DEFENSE - CORKFENDERS  
FENDER

Omtrek cm.	90	100	110	120	140	190
stuk Fr						

AANVAARZAKJES vr. YACHTEN - DEFENSES pr. YACHT  
YACHTFENDERS - YACHTFENDER

n<sup>o</sup>1222 omgebroid met touw, opgevuld met kurk

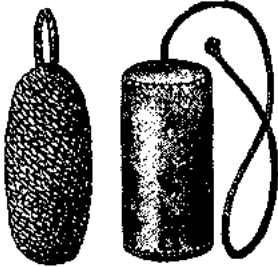

N<sup>o</sup>1222

N<sup>o</sup>1223

Afmet. in cm.	∅ 10x20	∅ 12x25	∅ 15x30	∅ 20x40
stuk Fr				

n<sup>o</sup>1223 Overtrek in witte katoen, opgevuld met plastic

Afmet. in cm.	∅ 7½x20	∅ 12x25	∅ 15x30	∅ 20x40
stuk Fr				

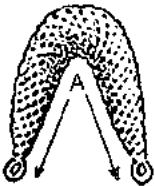

N<sup>o</sup> 1224

n<sup>o</sup>1224 VOORFENDERS - DEFENSES DE PROUE - STEMFENDERS  
KOPFENDER

Binnenlengte in cm.	40	60
stuk Fr		

n<sup>o</sup>1225 ACHTERFENDERS - DEFENSES DE POUPE - POOPFENDERS  
HINTERFENDER



N<sup>o</sup> 1225

Lengte in cm.	40	60
stuk Fr		

n<sup>o</sup>1030 VEILIGHEIDSBANDEN - CEINTURES DE SURETE  
LIFE BELTS - SICHEREITSBÄNDER



N<sup>o</sup>1030

stuk Fr

n<sup>o</sup>1050 ASSEZAKKEN - SACS A CENDRES - ASHBAGS  
ASCHENSÄCKE

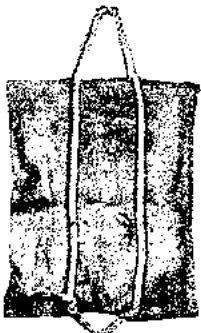

N<sup>o</sup> 1050

in Sisal st. Fr  
in Jute st. Fr

Prijzen opgesteld den

ZONDER VERBINTENIS

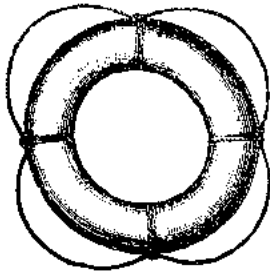

Nr.1310 & 1311

REDDINGSBOEIEN - BOUEES DE SAUVETAGE  
LIFEBUOYS - RETTUNGSBOJEN

	Buiten Ø in cm.	54	60	70	75
n°1310	in kurk stuk Fr				
n°1311	in platic st. Fr				

De Reddingsboei van Ø 75 cm. beantwoordt aan de vereischten van de BZI



n° 1323

REDDINGSGORDEL - CEINTURES DE SAUVETAGE  
JACKETS - RETTUNGSURTEL

Overtrek in oranje doek  
Vulsel in Styropor

- n°1323 model " PETER " st. Fr
- n°1324 model " BESTO " st. Fr
- n°1327 model " HENRY " st. Fr

Deze drie modellen beantwoorden aan de vereischten van de BZI

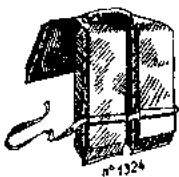

n°1324

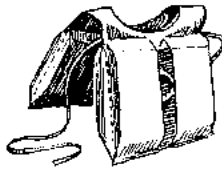

N° 1327

- n°1325 REDDINGSGORDELS vr. KINDEREN  
CEINTURES DE SAUVETAGE pr. ENFANTS

Overtrek in geplastifieerd oranje doek, vulsel in Styropor

stuk Fr



n°1326

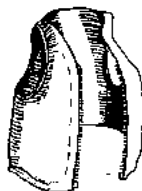

N° 1326

- n°1326 REDDINGSVEST GEPLASTIFIEERD met RITZ SLUITING  
GILET DE SAUVETAGE PLASTIPIE avec TIRETTE

" SOJABELT "

Drijfvermogen Kg.	20	40	60
stuk Fr			

Drijfvermogen Kg.	80	100	130
stuk Fr			

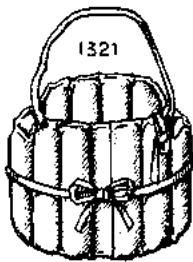

1321

- n°1321 REDDINGSGORDELS in KAPOK  
CEINTURES DE SAUVETAGE en KAPOK

	model	klein	groot
Wit stuk Fr			
Oranje st. Fr			

Prijzen opgesteld den

ZONDER VERBINTENIS



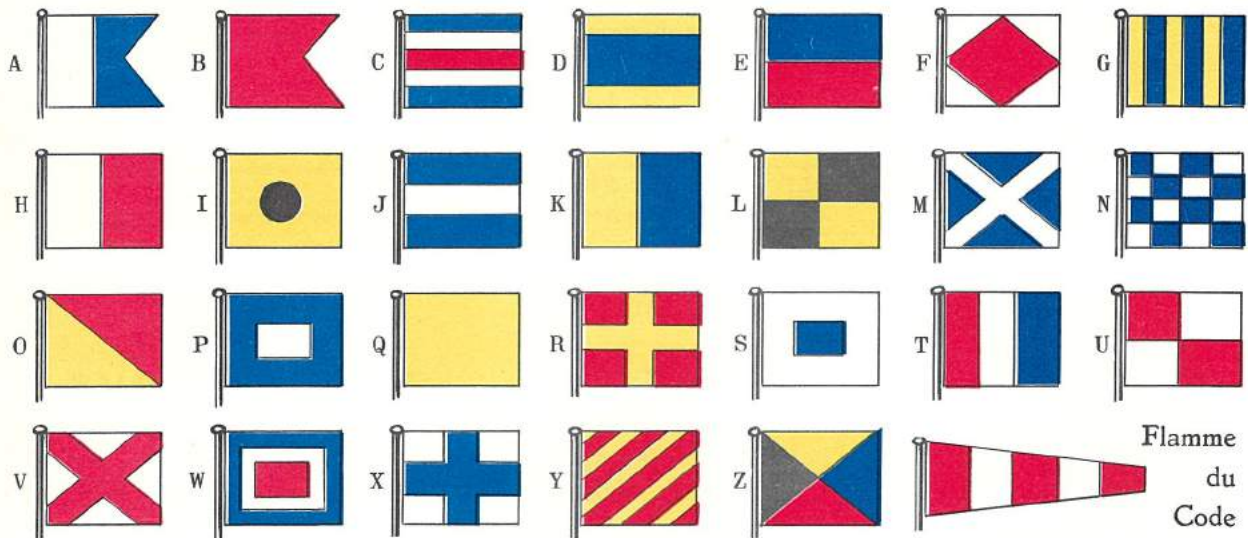

Flamme  
du  
Code

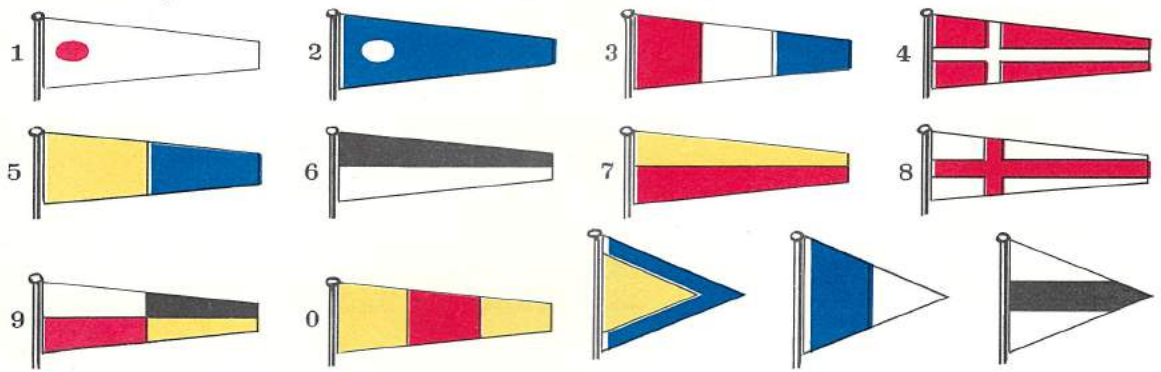

1er Substitut    2e Substitut    3e Substitut

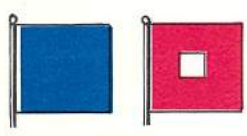

n°1420 SEINVLAGGEN - PAVILLONS DE SIGNALISATION  
SIGNALFLAGS - SIGNALFLAGGEN

Afmetingen cm.	35x50	50x60	60x70	70x95
Effen st. Fr				
Kanaalvl. st. Fr				



n°1506 BELGISCHE VLAGGEN met KROON  
DRAPEAUX BELGES avec COURONNE

Afmetingen cm.	35x50	50x75	60x90	70x105
stuk Fr				
Afmetingen cm.	75x113	100x150	120x180	
stuk Fr				



n°1510 CLUBVLAGGEN - PAVILLONS DE CLUB  
R.Y.C.B.

Maten cm.	26x40	35x55	45x70	60x90
stuk Fr				
S.R.N.A.				



Maten cm.	25x50	35x70	45x90	60x120
stuk Fr				

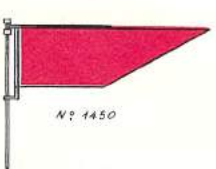

n°1450 WINDWIJZERS - GIROUETTES - WINDVANES  
VERKLIKKER

Maten cm.	9 x 21	14 x 45
stuk Fr		

n°1425 INTERN. CODEVLAGGEN - PAVILLONS DU CODE INTERN.  
 INTERN. CODEFLAGS - INTERN. CODEFLAGGEN

Letters cm.	25x35	35x45	50x60	60x70	75x90	100x120	120x145	140x170
A - B								
C								
D - E								
F								
G								
H								
I								
J - K - L								
M								
N								
O								
P								
Q								
R								
S								
T - U								
V								
W								
X								
Y								
Z								

Nummers cm.	20x60	30x85	40x120	50x140	55x180	80x225	100x275	120x290
AP								
1 - 2								
3								
4								
5								
6 - 7								
8								
9								
0								

Vervangwimpels cm.	35x50	40x60	60x90	75x100	90x130	120x150	140x190	180x230
S. 1								
S. 2								
S. 3								

Het stel Fr

n°1330 VLAGGENDOEK - ETAMINES DE PAVILLONS - BUNTING - FLAGGENTUCH

Breedte cm.	50	60	70	75	100
Wol met. Fr					
Enkeline MFr					

Prijzen opgesteld den

ZONDER VERBINTENIS

n°1505 VLAGGEN VAN LANDEN - PAVILLONS NATIONAUX - FLAGS OF NATIONS  
 FLAGGEN VON LÄNDERN  
 maten in cm.

BELGIË	<u>35x50</u>	<u>50x75</u>	<u>60x90</u>	<u>70x105</u>	<u>75x113</u>	<u>100x150</u>
	<u>120x180</u>	<u>150x225</u>	<u>200x300</u>	<u>250x375</u>	<u>300x400</u>	
BRAZILIË	<u>100x150</u>					
DENEMARKEN	<u>70x93</u>	<u>84x111</u>	<u>100x130</u>	<u>112x148</u>		
DUITSCHLAND WEST	<u>70x100</u>	<u>75x113</u>	<u>100x150</u>	<u>120x180</u>		
EGYPTE	<u>100x150</u>	<u>120x180</u>				
FINLAND	<u>77x126</u>	<u>99x162</u>	<u>110x180</u>	<u>121x198</u>		
FRANKRIJK	<u>70x100</u>	<u>100x150</u>	<u>120x180</u>			
GRIEKENLAND	<u>72x108</u>	<u>99x149</u>	<u>117x175</u>	<u>126x190</u>		
GROOT BRITANNIË	<u>30x60</u>	<u>40x80</u>	<u>60x120</u>	<u>70x140</u>	<u>100x200</u>	
ITALIË	<u>75x113</u>	<u>100x150</u>	<u>120x180</u>	<u>150x225</u>		
NEDERLAND	<u>50x75</u>	<u>70x105</u>	<u>100x150</u>	<u>120x180</u>	<u>150x225</u>	
NOORWEGEN	<u>112x154</u>	<u>128x176</u>	<u>144x198</u>	<u>160x220</u>		
PANAMA	<u>80x120</u>	<u>100x150</u>	<u>120x180</u>	<u>150x225</u>		
POLEN	<u>100x150</u>	<u>120x180</u>	<u>150x225</u>			
PORTUGAL	<u>70x105</u>	<u>100x150</u>	<u>120x180</u>	<u>150x225</u>		
RUSLAND	<u>100x200</u>	<u>120x240</u>	<u>140x280</u>			
SPANJE	<u>70x105</u>	<u>95x145</u>	<u>115x175</u>			
VERENIGDE STATEN	<u>104x192</u>	<u>117x216</u>				
YUGOSLAVIË	<u>100x150</u>					
ZWEDEN	<u>70x112</u>	<u>100x160</u>	<u>120x192</u>	<u>140x224</u>		

Prijzen opgesteld den

ZONDER VERBINTENIS

n°1410 SEINBOEKEN - LIVRES DE CODE  
CODEBOOKS - CODEBUCHER

Nederlands st. Fr  
Frans st. Fr  
Engels het paar Fr



N° 4140



n° 4142

VLAGWARTELS - EMERILLONS pr. PAVILLONS  
FLAGSWIVELS - FLAGGENWIRBEL

Nummer	4140	4142	4142
Lengte mm.		60	90

stuk Fr

=====

KOORDLADDERS - ECHELLES en CORDAGE  
PILOTLADDERS - TAULEITER

Aantal sporten per ladder	5/9	10/19	20/30
n°3905 per sport Fr			
n°3906 per sport Fr			
n°3907 Yachtladder per sport Fr			

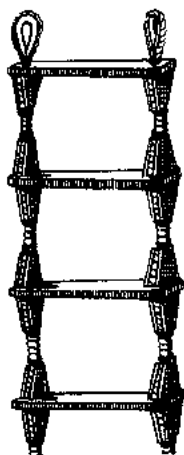

N° 3905

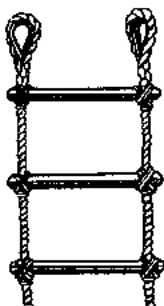

N° 3906

TREDEN - ECHELONS - STEPS - TRITTE

n°3915 platte sport (ladder 3905) st. Fr  
lange platte sport vr. dito st. Fr

n°3916 ronde sport (ladder 3906) st. Fr

n°3917 platte sport (yachtladder) st. Fr

LADDERSPEEN - COINS pr. ECHELLES

n°3920 vr. ladder n°3905 st. Fr

n°3921 vr. ladder n°3907 st. Fr

n°5203 TRAP met DRAAIBARE HAKEN  
ECHELLE avec CROCHETS PLIABLES

Beslag in aluminium, treden  
in hout

Met 3 treden st. Fr

Met 4 treden st. Fr

n°3918 BOOTSMANSTOEL - CHAISE DE GABIER  
BOATWAIN'S CHAIR - BOOTMANN'SSTUHL

stuk Fr

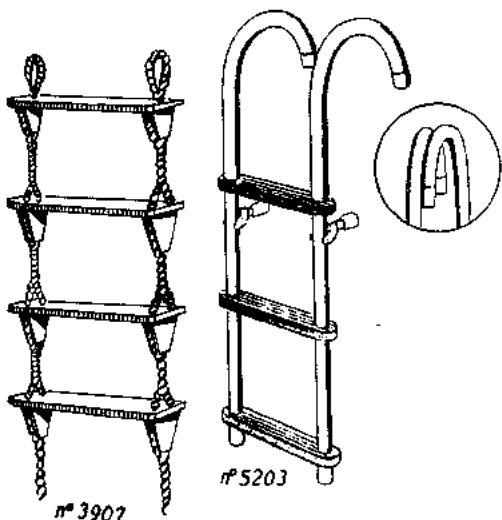

n° 5203

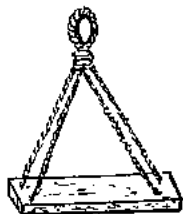

N° 3918

Prijzen opgesteld den

ZONDER VERBINTENIS

KATOENDOEK - TOILES DE COTON - COTTONDUCK - BAUMWOLLENTUCH

Prijzen per lopende meter

B r e e d t e i n c m .

Merken	91	103	120	140	200
n°1610			r u w		
n°1613			b r u i n		
n°1614			k h a k i		
n°1615			g r o e n		
n°1616			o r a n j e		
n°1617			b l a u w		
n°1618			g r i j s		
n°1619			h a v a n a		

YACHTDOEK - TOILES pr. YACHT - YACHTDUCK - YACHTTUCH

Katoen, ongebleekt in 91 cm. breed

Merken						
loop. M. Fr						

Teryleen in 81 cm. breed

Merken						
kleur	wit	wit	wit		rood	rood
loop. M. Fr						

Prijzen opgesteld den

ZONDER VERBINTENIS

n°1605 ZEILDOEK - TOILES A VOILE - SAILCLOTH - SEGELTUCH

in 61 cm. breed

MERKEN	EV1	EV2	EV3	EC1	EC2	EC3
loop. M. Fr						

PRESENNINGDOEK - TOILES A PRELART & A BACHE  
TARPAULIN CANVAS - PRESENNINGTUCH

Prijzen per lopende meter

n°	Merken	B r e e d t e i n c m .				
		80	91	103	120	140
n°1705						
n°1710						
n°1715						

n°1720 PRESENNINGEN & DEKZEILEN - PRELARTS & BACHES TARPAULINS  
PRESENNINGEN  
rechthoekig van 30 M2 en meer per vierkante meter gemaakt  
in doek  
de M2 Fr

n°1630 INPAKDOEK - TOILES D'EMBALLAGE - PACKING CLOTH  
Breedte in cm. 100 140  
loop. meter Fr

n°1635 SINGEL - SANGLE  
in rollen van 25 meter  
Breedte mm. 30 35  
de rol Fr

n°1650 BOEIENLINT - RUBANS pr. CEINTURES DE SAUVETAGE  
JACKETTAPES - BAND für RETTUNGSGURTEL  
in rollen van 50 meter  
Breedte in mm. 26 30  
de rol Fr  
de meter Fr

Prijzen opgesteld den ZONDER VERBINTENIS

n°1805 RECHTE SLUITINGEN - MANILLES DROITES - D SHACKLES  
D SCHAKEL

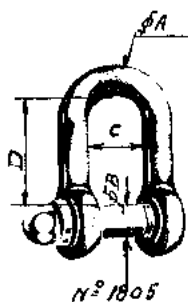

Doorm. Ax B mm.	4,8	6,3	7,9	9,5	11,1	12,7
Doorm. Ax B duim.	3/16	1/4	5/16	3/8	7/16	1/2
Wijdte C mm.	10	13	16	19	22	25
Lengte D mm.	19	25	32	38	41	48
Werkbel. Kg.	75	125	156	250	400	625
Zwart st. Fr						
Gegalv. st. Fr						
Doorm. Ax B mm.	13 x 16	16 x 19	19 x 22	22 x 25	25 x 28	
Doorm. Ax B duim.	1/2 x 5/8	5/8 x 3/4	3/4 x 7/8	7/8 x 1	1 x 1.1/8	
Wijdte C mm.	29	32	38	44	51	
Lengte D mm.	54	63	73	83	95	
Werkbel. Kg.	610	1120	1625	2280	3000	
Zwart st. Fr						
Gegalv. st. Fr						

SCHAKELS vr. LAADBOMEN - MANILLES pr. MATS DE CHARGE  
SHACKLES for DERRICKS - SCHAKEL für LADEBAUME

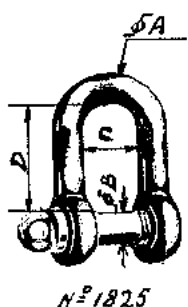

Doorm. Ax B mm.	25x28	25x32	28x35	32x38	35x41
Doorm. Ax B duim.	1x1.1/8	1x1.1/4	1.1/8x1.3/8	1.1/4x1.1/2	1.3/8x1.5/8
Wijdte C mm.	38	42	47	51	56
Lengte D mm.	92	100	110	120	130
Werkbel. Kg.	3500	4050	5050	6100	7400
n°1825 st. Fr					
n°1826 st. Fr					

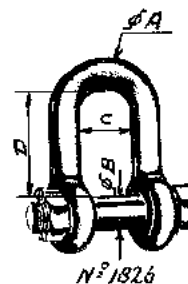

Doorm. Ax B mm.	38 x 44	41 x 51	48 x 57	54 x 63
Doorm. Ax B duim.	1.1/2 x 1.3/4	1.5/8 x 2	1.7/8 x 2.1/4	2.1/8 x 2.1/2
Wijdte C mm.	61	67	77	86
Lengte D mm.	140	155	180	210
Werkbel. Kg.	8700	10700	13900	17700
n°1825 st. Fr				
n°1826 st. Fr				

n°1815 SCHAKELS met GEFREESDE KOP - MANILLES à TETE FRAISEE  
SHACKLES with COUNTERSUNK HEADPIN  
SCHAKEL mit SCHLITBOLZEN

Afmetingen & Werkbelasting als schakel n°1825

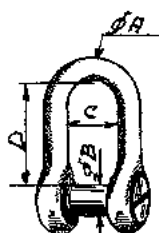

Doorm. Ax B mm.	22 x 25	25 x 28	25 x 32	28 x 35
Doorm. Ax B duim.	7/8 x 1	1 x 1.1/8	1 x 1.1/4	1.1/8x1.3/8
stuk Fr				

N°1815

n°1810 1/2 GEDRAAIDE GEGALV. SCHAKELS  
MANILLES TORDUES GALVANISEES  
1/2 TURNED GALVAN. SHACKLES



Doorm. in mm.	6,3	7,9	9,5
stuk Fr			

Prijzen opgesteld den

ZONDER VERBINTENIS

n°1905 HARPSLUITINGEN - MANILLES FORME LYRE  
HARPSHACKLES - GESCHWEISTE SCHÄKEL

Doorm. Ax B mm.	4.8	6.3	7.9	9.5	11.1	12.7
Doorm. Ax B duim.	3/16	1/4	5/16	3/8	7/16	1/2
Wijdte C mm.	10	13	16	19	22	25
Lengte D mm.	19	25	32	38	41	48
Doorm. E mm.	14	19	24	29	33	38
Werkbel. Kg.	50	100	125	250	375	500
Zwart st. Fr						

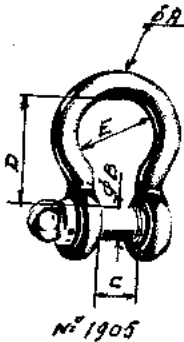

Gegalv. st. Fr

Doorm. Ax B mm.	13x16	16x19	19x22	22x25	25x29
Doorm. Ax B duim.	1/2x5/8	5/8x3/4	3/4x7/8	7/8x1	1x1.1/8
Wijdte C mm.	27	33	38	43	49
Lengte D mm.	60	70	80	95	110
Doorm. E mm.	46	56	64	72	84
Werkbel. Kg.	750	1150	1700	2300	3000
Zwart st. Fr					

Gegalv. st. Fr

Doorm. Ax B mm.	29x32	32x35	35x38	38x41
Doorm. Ax B duim.	1.1/8x1 1/4	1 1/4x1.3/8	1.3/8x1 1/2	1 1/2x1.5/8
Wijdte C mm.	54	58	62	66
Lengte D mm.	120	130	140	150
Doorm. E mm.	92	98	106	112
Werkbel. Kg.	3650	4400	5250	6600
Zwart st. Fr				

n°1910 BOEISLUITINGEN - MANILLES D'AFFOURCHE  
MOORINGSHACKLES - VERTHUSCHÄKEL

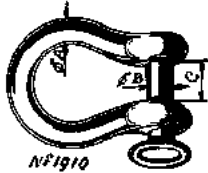

Doorm. Ax B mm.	29x32	32x35	38x41	44x51	51x57
Doorm. Ax B duim.	1.1/8x1 1/4	1 1/4x1.3/8	1 1/2x1.5/8	1 3/4x2	2x2 1/4
Wijdte C mm.	86	95	114	133	152
Werkbel. Kg.	2500	3100	4200	6500	8400
stuk Fr					

n°2005 SPLITSCHALMEN - MAILLONS A RIVER - CONNECTING LINKS  
KETTENVERBINDUNGSGLIEDER



Doorm. in mm.	8	10	12	14	16	18
stuk Fr						
Doorm. in mm.	20	22	25	28	32	35
stuk Fr						

n°2006 " STOP " SCHALM - MAILLONS " STOP "  
" STOP " LINK - " STOP " SCHALM

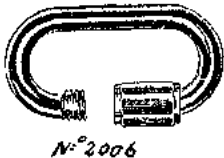

Doorm. in mm.	5	6	7	8	10
Binnenmanten mm.	39x15	45x17	47x17	56x20	68x20
Werkbel. Kg.	400	500	640	900	1400
stuk Fr					

Prijzen opgesteld den

ZONDER VERBINTENIS



LAADHAKEN - CROCHETS DE CHARGEMENT - CARGO HOOKS  
LADEHAKEN  
model Liverpool

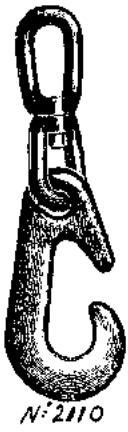

Werkbelasting Tonnen	1½	3	5
n°2105 zonder wartel st. Fr			
n°2110 met wartel st. Fr			

n°2115 HIJSHAKEN - CROCHETS DE PALAN - CRANE HOOKS  
LASTHAKEN mit ÖSE

Werkbel. T.	¼	1	1½	2	3
AIB K4 T.	¼	0,8	1,17	1½	2,4
stuk Fr					
Werkbel. T.	4	5	7½	10	
AIB K4 T.	3,3	3,7	6½	8,1	
stuk Fr					



n°2116 RIVEERHAKEN - CROCHETS avec TIGE à RIVER  
SHANKHOOKS - LASTHAKEN mit ZAPPEN

Werkbel. T.	¼	1	1½	2	3
AIB K4 T.	0,3	0,6	1,1	1,4	2,2
stuk Fr					
Werkbel. T.	4	5	6	7½	
AIB K4 T.	3	4,1		6,4	
stuk Fr					



n°2140 LAADHAKEN met VEILIGHEIDSKLEP  
CROCHETS DE CHARGEMENT avec LANGUETTE  
CRANE HOOKS with SPRING  
SICHERHEITSLASTHAKEN

Werkbel. T.	¼	1	1½	2	3
stuk Fr					

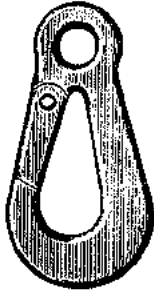

n°2140

n°2120 TALIEHAKEN - CROCHETS AVEC COSSE  
TACKLE HOOKS - TALJEHAKEN

Lengte Haak mm.	125	150	175	200	250
vr. touw Ø mm.	16	20	24	28	28
Werkbelasting Kg.	350	550	750	1000	1000
stuk Fr					



n°1840 RONDE RINGEN - ANNEAUX RONDS - RINGS  
RINGE

Doormeters mm.	22x100	28x120	30x150	32x140	35x150
Werkbelast. T	1½	2	2	2½	3
stuk Fr					

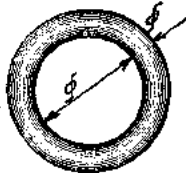

N°1840

Prijzen opgesteld den ZONDER VERBINTENIS

n°2117 OOGBOUTEN - OEILLETS PITONS - EYEBOLTS  
AUGBOLZE

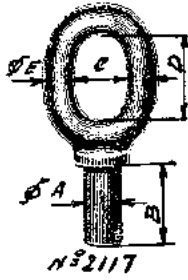

A	B	C	D	E	Werkbelasting Tonnen	stuk Fr
19	50	25	43	16	1,2	
22	75	34	50	16	1,5	
28	76	28	57	19	2,2	
28	50	32	54	22	2,7	
30	75	39	70	24	3	
35	83	35	70	25	4	
38	89	38	78	29	5	
38	92	44	85	32	6	
41	95	48	92	35	7	
47	102	52	105	37	9	
54	114	57	116	38	10	
60	127	63	130	46	14	
65	130	66	135	47	16	
70	150	76	165	53	20	

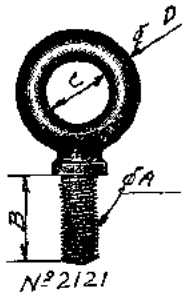

n°2121 DYNAMOBOUTEN - PITONS pr. DYNAMO  
DYNAMOBOLTS - RINGSCHRAUBEN

ww draad A	5/16	3/8	1/2	5/8	3/4	7/8	1
lengte B mm.	19	19	25	29	32	41	44
Doorm. C mm.	22	22	29	32	41	44	51
Doorm. D mm.	9,5	9,5	9,5	12,7	15,9	17,5	19
stuk Fr							

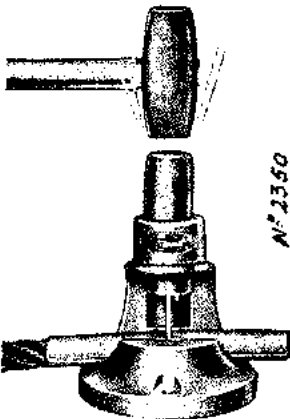

n°2350 STAALDRAADKAPPERS - COUPE-CABLES  
CABLECUTTERS - DRAHTSEILSCHNEIDER

Nummer	A (1)	B (1A)	C (2)
vr. kabel tot $\emptyset$ mm.	25	28	38
stuk Fr			

n°2352 BOVENMESSEN - COUTEAUX SUPERIEURS - BLADES  
OBENMESSER

Nummer	AB (1 & 1A)	C (2)
stuk Fr		

n°2353 ONDERMESSEN - COUTEAUX INFERIEURS - DIES  
UNTERMESSER

Nummer	A (1)	B (1A)	C (2)
paar Fr			



n°1950 TEGENWICHT - CONTREPOIDS - COUNTER POISE  
GEGENGEWICHT

Tweedeleig 8 Kg. stuk Fr

Prijzen opgesteld den ZONDER VERBINTENIS

GEGALV. PUNTKOUSEN - COSSES COEUR GALV.  
 GALV. HEARTTHIMBLES - VERZINKTE DRAHTSEILKAUSCHEN

n°2210 vr. staaldraadtouw - pr. câble en acier  
 for steelwirerope - für Drahtseil



vr. kabel Ø mm.	4	6	8	10	12	14
vr. kabel omtrek	½"	¾"	1"	1¼"	1½"	1¾"
volle lengte mm.						
binnenbreedte mm						
stuk Fr						
vr. kabel Ø mm.	16	18	20	22	24	26
vr. kabel omtrek	2"	2¼"	2½"	2¾"	3"	3¼"
volle lengte mm.						
binnenbreedte mm						
stuk Fr						
vr. kabel Ø mm.	28	32	36	40	50	19
vr. kabel omtrek	3½"	4"	4½"	5"	6"	
volle lengte mm.						
binnenbreedte mm						
stuk Fr						

n°2205 vr. kemptouwwerk - pr. cordage en chanvre  
 for hemprope - für Hanfseil



vr. touw Ø mm.	8	10	12	14	16	18	20
vr. touw omtrek	1"	1¼"	1½"	1¾"	2"	2¼"	2½"
volle lengte mm.							
binnenbreedte mm.							
stuk Fr							
vr. touw Ø mm.	22	24	28	32	36	40	
vr. touw omtrek	2¾"	3"	3½"	4"	4½"	5"	
volle lengte mm.							
binnenbreedte mm							
stuk Fr							

n°2211 ROESTVRIJE PUNTKOUSEN - COSSES COEUR en INOX

vr. kabel Ø mm.	3	4	5	6
stuk Fr				

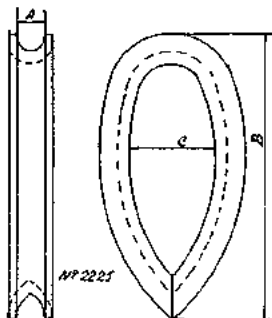

n°2225 DOORSCHUIVENDE KOUSEN vr. STAALDRAAD  
 COSSES INTERCOULISSANTES pr. CABLE en ACIER  
 REEVABLE THIMBLES for WIRE ROPE  
 HINDURSCIENDE KAUSCHEN für DRAHTSEIL

vr. kabel Ø mm.	16	20	24
vr. kabel omtrek	2"	2½"	3"
volle lengte mm.	170	210	244
binnenbreedte mm.	41	64	76
stuk Fr			

Prijzen opgesteld den

ZONDER VERBINTENIS

n°2305 KOUSEN vr. TOOGTROSSEN - COSSES pr. AUSSIÈRES  
HAWSER THIMBLES - KAUSCHEN für TROSSEN

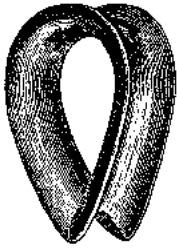

inwendig spoor mm.	44	51	63	76	89
inwendig spoor duimen	1 $\frac{3}{4}$	2	2 $\frac{1}{2}$	3	3 $\frac{1}{2}$
stuk + Kg.	1,7	2,4	3,2	4,6	5,6
zwart per Kg. Fr					
inwendig spoor mm.	102	113	127	140	152
inwendig spoor duimen	4	4 $\frac{1}{2}$	5	5 $\frac{1}{2}$	6
stuk + Kg.	8,4	12	16,6	26	28
zwart per Kg. Fr					

n°2310 RONDE KOUSEN - COSSES RONDES - ROUND THIMBLES  
RUNDKAUSCHEN



vr. touw $\phi$ mm.	6	7	8	10	12	14
buiten $\phi$ mm.	20	22	25	32	38	45
gegalvan st. Fr						
koper st. Fr						
vr. touw $\phi$ mm.	16	18	20	22	24	
buiten $\phi$ mm.	51	57	63	70	76	
gegalvan. st. Fr						

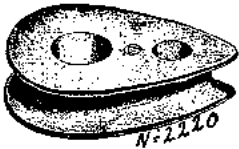

n°2220 GIETIJZERE KOUSEN - COSSES EN FONTE  
CAST IRON THIMBLES - GUSSEISERNE KAUSCHEN

inwendig spoor mm.	24	28	35	40
dikte mm.	35	40	45	52
volle lengte mm.	125	150	180	210
stuk Fr				



n°2230 BUIS vr. TOUWSTROP - TUBE pr. CORDAGE d'ESTROPE  
vr. touw  $\phi$  28 mm. stuk Fr

KABELSOKKEN - DOUILLES pr. CABLES - WIRE ROPESOCKETS  
SEILHÜLSEN

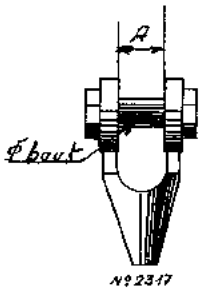

Kabel omtrek	1"	1 $\frac{1}{2}$ "	2"	2 $\frac{1}{2}$ "	3"	3 $\frac{1}{2}$ "
Werkbel. T.	0,75	1,6	3,15	5	8	10
	Type n°			2	3	17
Wijdte A mm.	18	28	36	45	56	63
$\phi$ bout duim.	9/16	7/8	1.1/8	1.3/8	1.3/4	1.7/8
stuk Fr						

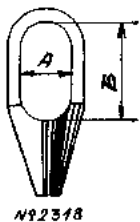

	Type n°			2	3	18
Wijdte A mm.		44	54	67	75	
Lengte B mm.		88	108	134	150	
stuk Fr						

Prijzen opgesteld den

ZONDER VERBINTENIS

n°2315 STAALDRAADKLEMMEN - SERRE-CABLE - WIRE-GRIPS  
DRAHTSEILKLEMMEN  
Gegalvaniseerd

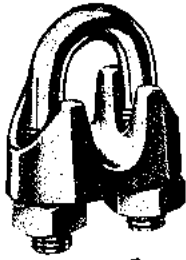

N°2315

vr. kabel Ø mm.	3	4	6	8	10
vr. kabel Ø duim.	1/8	3/16	1/4	5/16	3/8
stuk Fr					
vr. kabel Ø mm.	12	14	16	19	22
vr. kabel Ø duim.	1/2	9/16	5/8	3/4	7/8
stuk Fr					
vr. kabel Ø mm.	25	28	32	38	50
vr. kabel Ø duim.	1	1.1/8	1.1/4	1.1/2	2
stuk Fr					

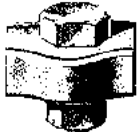

n°2311

STAALDRAADKLEMMEN - SERRE-CABLE - WIRE-GRIPS  
DRAHTSEILKLEMMEN  
Gegalvaniseerd



N°2312

vr. kabel Ø mm.	3	4	6	8
n°2311 Simplex st. Fr				
n°2312 Duplex st. Fr				

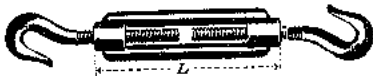

N°2510

GEGALVAN. SPANSCHROEVEN - TENDEURS GALVAN.  
GALVAN. STRAINING SCREWS - VERZ. SPANNSCHLÖSSER



n°2511

Doorm. draad mm.	6,3	7,9	9,5	12,7	15,8
Ø draad duimen	1/4	5/16	3/8	1/2	5/8
Lengte huis mm.	110	110	125	140	170
Werkbel. haak Kg.	70	80	90	150	250
Werkbel. oog Kg.	110	200	300	500	750
stuk Fr					



n°2512

n°2545 KLEPSCHROEVEN - RIDOIRS à LEVIER

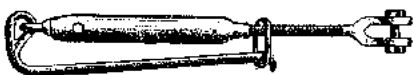

N°2545

Ø draad mm.	9,5	12,7	15,8	19	22,2	25,4
Ø draad duim.	3/8	1/2	5/8	3/4	7/8	1
stuk Fr						

ROESTVRIJE WANTSCHROEVEN - RIDOIRS en ACIER INOXYDABLE  
RIGGING SCREWS in STAINLESS STEEL  
ROESTVRIJE SPANNSCHRAUBEN



N° 2521

Doormeter draad mm.	6,3	7,9	9,5	12,7
Doormeter draad duimen	1/4	5/16	3/8	1/2

n°2521 met 2 vorken st. Fr



N° 2522

n°2522 m/vork & oog st. Fr



N° 2523

n°2523 verlengingst. st. Fr

Prijzen opgesteld den

ZONDER VERBINTENIS

n°2514 WANTSCHROEVEN met 2 VORKEN - RIDOIRS à 2 FOURCHES  
 RIGGING SCREWS with 2 LUGS - SPANNSCHRAUBEN mit 2 GABELN  
 vorken gegalvaniseerd, koperen huis midden zeskantig



∅ draad mm.	6,3	7,9	9,5	12,7
∅ draad duimen	1/4	5/16	3/8	1/2
stuk Fr				

n°2515 WANTSCHROEVEN met 2 VORKEN - RIDOIRS à 2 FOURCHES  
 RIGGING SCREWS with 2 LUGS - SPANNSCHRAUBEN mit 2 GABELN

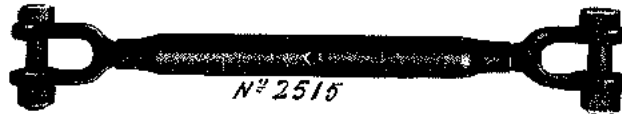

∅ draad mm.	9,5	12,7	15,8	19	22,2	25,4
∅ draad duimen	3/8	1/2	5/8	3/4	7/8	1
Werkbel. Kg.	300	500	750	1125	1625	2125
stuk Fr	Z W A R T					
stuk Fr	G E G A L V A N I S E E R D					
∅ draad mm.	28,5	31,7	38	44,4	50,8	57,1
∅ draad duimen	1.1/8	1.1/4	1.1/2	1.3/4	2	2.1/4
Werkbel. Kg.	2750	3750	5125	7000	9125	11500
Zwart stuk Fr						

ZWARTE WANTSCHROEVEN - RIDOIRS NOIRS - S/C RIGGING SCREWS  
 SCHWARZE SPANNSCHRAUBEN



∅ draad mm.	12,7	15,8	19	22,2	25,4	28,5
∅ draad duimen	1/2	5/8	3/4	7/8	1	1.1/8
Werkbelasting Kg.	500	750	1125	1625	2125	2750
n°2519 - 2 O. st.Fr						
n°2520 - V & O st.Fr						
∅ draad mm.	31,7	38	44,4	50,8	57,1	
∅ draad duimen	1.1/4	1.1/2	1.3/4	2	2.1/4	
Werkbelasting Kg.	3750	5125	7000	9125	11500	
n°2519 - 2 O. st.Fr						
n°2520 - V & O st.Fr						

Prijzen opgesteld den

ZONDER VERBINTENIS

SCHRABBERS - RACLOIRS - SCRAPERS - SCHABER



N° 2613

stuk Fr

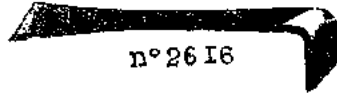

n°2616

stuk Fr

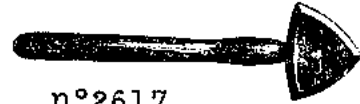

n°2617

stuk Fr

ROESTSTEKERS - GRATTOIRS - SLICES - ROSTSTECHER

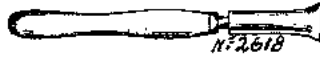

N°2618

stuk Fr



n°2619

stuk Fr

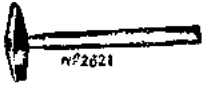

n°2621

n°2621 PIKHAMERS - MARTEAUX à PIQUER  
CHIPPING HAMMERS - PICKHAMMER

stuk Fr



N°2624

n°2624 VEILIGHEIDSBRILLEN - LUNETTES en ALUMINIUM  
CHIPPING GOGGLES

stuk Fr



n°2604

n°2603

n°2603 BOOTSCHAKEN - CROCS DE GAFFE - BOATHOOKS  
BOOTSHAKEN  
in koper

n°2603 Ø 35x175 mm. Lang stuk Fr

n°2604 wijdte 17x205 mm. Lang stuk Fr

n°2605 BOOTSCHAKEN - FERS DE GAFFE - BOATHOOKS  
BOOTSHAKEN  
in ijzer



N°2605

binnen Ø mm.	25	30	35	40	45	50	55
zwart st. Fr							
gegalv. st. Fr							

n°2623 REDDINGSHAAK - CROCHET DE SAUVETAGE  
RETTUNGSHAKEN

stuk Fr

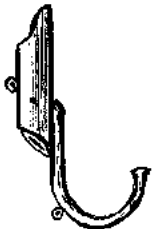

n°2623

n°2606 HAAKSTELLEN - GAFFES - SHAFTS

Lengte Met.	4	5	6	7
stuk Fr				

n°2600 BOOMKLAUWEN - FOURCHES DE PERCHE

Binnen Ø mm.	80	90	100
stuk Fr			

BOMEN - PERCHES

Lengte Meters	8	9	10
geladen stuk Fr			

n°2601

n°2602 ledig stuk Fr			
----------------------	--	--	--

n°2602

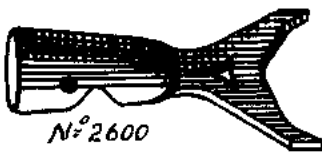

N°2600

Prijzen opgesteld den ZONDER VERBINTENIS



n°2015 GEGALV. ROEIJZERS - DAMES DE NAGE GALVAN.  
GALVAN. ROWLOCKS - VERZ. RUDDERGABELN

Wijdte mm.	50	57	65	75
∅ stang mm.	12	13	14	17
Lengte stang mm.	100	100	115	125
stuk fr				



n°2017 ROEIJZERSPLATEN - PLAQUES pr. DAMES DE NAGE  
ROWLOCKPLATES - RUDDERGABELPLATTEN  
Gegalvaniseerd

Afmetingen mm.	50x30	50x30	60x35	70x40
vr. roeijzer	50	57	65	75
stuk fr				



n°2018 ROEIJZERSDOLLEN - DOUILLES pr. DAMES DE NAGE  
ROWLOCKSOCKETS - RUDDERGABELBUCHSEN  
Gegalvaniseerd

Afmeting plaat mm.	70 x 30	70 x 30
vr. roeijzer	50	57
stuk fr		



n°2019 ZIJDEDOLHOUDERS  
DOUILLES DE COTE pr. DAMES DE NAGE  
SIDE ROWLOCKSOCKETS - SEITE RUDDERGABELBUCHSEN  
Gegalvaniseerd

vr. roeijzer van 50 mm. stuk fr

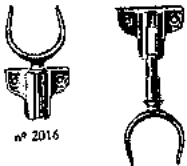

n°2016 OMKLAPBARE ROEIJZERS - DAMES DE NAGE RABATTABLES  
TURNOVER ROWLOCKS - HERUNTERKLIAPPEN GABELN  
Gegalvaniseerd

Wijdte 50 mm. stuk fr



n°3960 MASTSTELLEN - POMMES DE MAT - MASTHEAD TRUCKS  
FLAGGENKNOPF

Doormeter mm.	90	100	125	150	175
stuk fr					

N°3960

n°3830 MASTKRALEN - PERLES DE MAT - PARREL BEADS

Doormeter mm.	20	25	30	40	50
stuk fr					



N°3830

n°1900 VISBOUTEN - BOULON PLONGEUR

stuk fr



N°1900

Prijzen opgesteld den

ZONDER VERBINTENIS



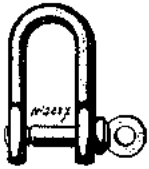

n°2627 KOPERE SCHAKELS - MANILLES EN CUIVRE  
COPPER SHACKLES - MESSING SCHÄKEL

Doorm. mm.	4	5	7	9
stuk Fr				

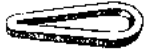

n°1875

n°1875 SCHAKELSLEUTEL - CLEF DE MANILLE - SHACKELKEY  
SCHÄKELÖFFNER  
Koper

stuk Fr

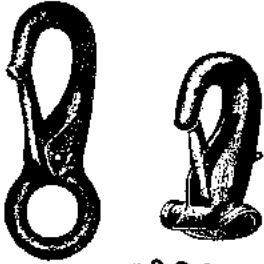

No. 2805

n°2807

n°2805 KLIPHAKEN - CROCHETS avec LANGUETTE  
CLIPHOOKS - KLIPPHAKEN  
Gegalvaniseerd

Lengte mm.	50	70	85	100
stuk Fr				

n°2807 STAGLEUVERS - BAGUES DE FOC - SAILHANKS  
STAGREITER  
Gegalvaniseerd

Lengte mm.	35	50	65
stuk Fr			

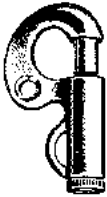

n°2809

n°2809 STAGLEUVERS - BAGUES DE FOC - SAILHANKS  
STAGREITER  
Koper

Lengte mm.	40	50	60	70
Opening mm.	6	8	13	15
stuk Fr				

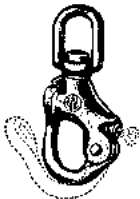

n°2817

n°2817 KLEPLEUVERS met WARTELOOG  
MOUSQUETON à PISTON EMERILLON  
SWIVEL SNAP SHACKLE - FOCKSCHÄKEL & WIRBELÖSE  
Koper

Lengte mm.	85	100
stuk Fr		

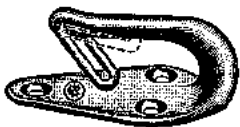

n°2607

n°2607 SLEEFHAAK - CROCHET DE HALAGE  
TOWING HOOK - SCHLEPPHAKEN  
Verchroomd

Lengte 100 mm. st. Fr

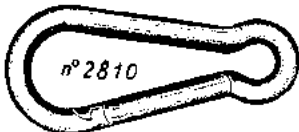

n°2810

KARABIJNHAKEN - PORTE-MOUSQUETON - SPRINGHOOKS  
KARABINERHAKEN

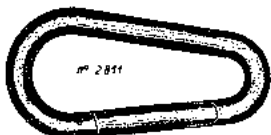

n°2810

n°2810

Afmetingen mm.	60x6	80x8	120x11	160x16	200x20
Blank st. Fr					
n°2811	Gegalv. st. Fr				

Prijzen opgesteld den

ZONDER VERBINTENIS

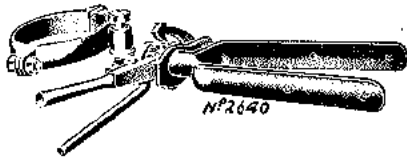

n°2640 GEGALV. PATENTREVERS - FERRURES de GUI GALV.  
GALVAN. REEFING GEARS - VERZ. REFFER

Doorm. Mast. mm.	Doorm. Boom mm.	stuk Fr
90	50	
100	50	

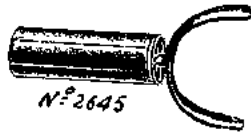

n°2645 KOPERE PATENTREVERS - FERRURES DE GUI CUIVRE  
COPPER REEFING GEARS - FEDERREFFER

Doorm. Mast. mm.	Doorm. Boom mm.	stuk Fr
90	45	
100	50	



n°2813 GEGALV. MASTBANDEN - FRETTE DE MAT GALVAN.  
GALVAN. MASTBANDS - VERZ. TOPPBANDE

Binnen Doorm. mm.	40	50	63
stuk Fr			



n°2850 GEGALV. MASTRINGEN - ROCAMBEAUX GALV.  
GALV. TRAVELLERS - VERZ. AUSHOLRING

Binnen Doorm. mm.	110	130	150
stuk Fr			



n°2815 KOPERE GLIJLEUVERS - GLISSIERES DE MAT CUIVRE  
BRASS SLIDES - SCHIENE

vr. platte rail mm.	20 x 2	25 x 3
stuk Fr		



n°2816 KOPERE GLIJLEUVERS - GLISSIERES DE MAT CUIVRE  
BRASS SLIDES - MASTRUTSCHER

vr. profielrail 19 mm. stuk Fr

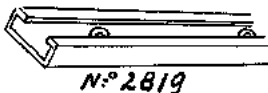

n°2819 MASTRAIL - RAIL pr. GLISSIERES  
TRACK for SLIDES - MASTSCHIENE

vr. glijleuver n°2816 de meter Fr

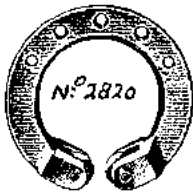

n°2820 SCHOOTRINGEN - CROISSANTS DE POULIE d'ECOUTE  
CLAWRINGS - SCHOTRINGE  
Gegalvaniseerd

Binnen Doorm. mm.	80	100
stuk Fr		

VLAGGESTOKHOUDERS - PORTE-HAMPE  
FLAGSTAFFSOCKETS - FLAGGENSTOCKHALTER

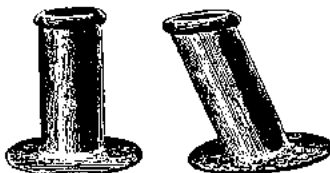

n°2630

n°2631

Doorm. mm.	16	20	24	30	35
gegalv. st. Fr					
koper st. Fr					
gegalv. st. Fr					
koper st. Fr					

2630

2631

Prijzen opgesteld den

ZONDER VERBINTENIS

n°2705 GEGALV. BOLDERS - DOUBLES BITTES GALVAN.  
GALV. BOLLARDS - VERZ. POLLER



No. 2705

Volle lengte cm.	15	20
stuk Fr		

n°2702 DUBBELE KRUISBOLDERS - DOUBLE BITTE en CROIX  
DOUBLE BITS - DOPPELKREUZPOLLER  
Gegalvaniseerd



n° 2702

Volle lengte cm.	25	32
stuk Fr		

n°2710 RECHTE BOEGKLAMPEN - CHAUMARDS DROITS  
STRAIGHT FAIRLEADS - GERADE KETTENKLUSEN



No. 2710

Volle lengte cm.	9½	11	12½
koper st. Fr			
Volle lengte cm.	15	20	25
gegalvan. st. Fr			

n°2711 SCHUINE BOEGKLAMPEN - CHAUMARDS OBLIQUES  
CURVED FAIRLEADS - SCHRÄGE KETTENKLUSEN



No. 2711

Volle lengte cm.	10	11	13
koper st. Fr			
Volle lengte cm.	12½	15	20
gegalvan. st. Fr			

KIKKERS - TAQUETS - CLEATS - BELEGKLAMPEN



No. 2715

n°2715 Lengte cm.	6	10	12
Verchroomd st. Fr			
Koper st. Fr			



No. 2716

n°2716 Lengte cm.	7½	10	12½	15	17½	20
Koper st. Fr						
Gegalv. st. Fr						



No. 2717

n°2717 Lengte cm.	10	20
Koper st. Fr		
Gegalvan. st. Fr		



No. 2718

n°2718 Lengte cm.	10	15	17½	20
Koper st. Fr				
Gegalvan. st. Fr				

Prijzen opgesteld den

ZONDER VERBINTENIS



N° 2660

n°2660 SCHOOTKLEMMEN - COINCEURS d'ECOUTE  
JAM CLEATS - SCHOTHALTER  
Verchromd

vr. touw tot  $\emptyset$  12 mm. st. Fr



N° 2661

SCHOOTKLEMMEN - COINCEURS d'ECOUTE  
JAM CLEATS - SCHOTHALTER  
in Hardweefsel

n°2661 zonder geleider vr. touw tot  $\emptyset$  10 mm. st. Fr



N° 2662

n°2662 met geleider vr. touw tot  $\emptyset$  mm. 10 16  
st. Fr



n°2425

n°2425 RINGPLATEN - ANNEAUX SUR PLAQUE  
RINGPLATES - ANLEGERINGE  
koper

Ring  $\emptyset$  5 x  $\emptyset$  33 mm. st. Fr

OOGBOUTEN - PITONS à ECROU - EYEBOLTS  
AUGBOLZEN

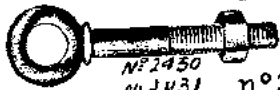

N° 2430  
N° 2431

n°2430 koper stang mm.  $\emptyset$  6x60 |  $\emptyset$  8x80 |  $\emptyset$  10x95 |  $\emptyset$  13x125 |  
stuk Fr

n°2431 gegalv. stang mm.  $\emptyset$  6x100 |  $\emptyset$  8x100 |  $\emptyset$  10x100 |  $\emptyset$  13x100 |  
stuk Fr



N° 2432

n°2432 OOGPLATEN - PITONS sur PLAQUE - EYEPLATES  
koper

afmetingen oog mm.  $\emptyset$  5x $\emptyset$  12 |  $\emptyset$  6x $\emptyset$  15 |  $\emptyset$  8x $\emptyset$  23 |  $\emptyset$  10x $\emptyset$  26 |  
stuk Fr



N° 2625

n°2625 SCHOOTOGEN - MARGOUILLETS - FAIRLEADS  
SCHOTLEITÖSEN

binnen doormeter 16 mm. stuk Fr



N° 2665

n°2665 DEKSTOPPEN - NABLES DE PONT - DECK SCREWS  
DECKVERSCHRAUBUNGEN  
koper

Binnendoormeter mm. 25 60  
stuk Fr



n° 2915

n°2915 KETTINGKLUIZEN - ECUBIERS - CHAINPIPES  
KETTENKLÜSEN

Gegalvaniseerd vr. ketting  $\emptyset$  mm. 8 10  
stuk Fr

Prijzen opgesteld den

ZONDER VERBINTENIS

n°3005 KLIPANKERS - ANGRES ARTICULEES  
STOCKLESS ANCHORS - KLAPPANKER



Gewicht $\pm$ Kgr.	5	9	12
Zwart per Kg. Fr			
Gegalv. per Kg. Fr			
Gewicht $\pm$ Kgr.	17	22	30
Zwart per Kg. Fr			
Gegalv. per Kg. Fr			

n°3105 DREGGEN met PALLEN - GRAPPINS à PATTES  
GRAPNELS with PRONGS - DRAGGEN mit PALLEN



Gewicht $\pm$ Kgr.	10	15	25
Zwart per Kg. Fr			

n°3100 PUNTDREGGEN - GRAPPINS à POINTES  
DRAGGEN mit SPITZEN



Gewicht $\pm$ Kgr.	1	2	3
Zwart per Kg. Fr			

n°3010 ANKERS met LOSSE STOK - ANGRES à JAS  
STOCKANCHORS - STOCKANKER

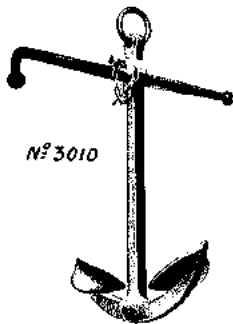

Gewicht $\pm$ Kgr.	8	10	12
Zwart per Kg. Fr			
Gegalv. per Kg. Fr			
Gewicht $\pm$ Kgr.	15	20	25
Zwart per Kg. Fr			

n°3110 VOUBARE DREGGEN - GRAPPINS à BRAS MOBILES  
FOLDING GRAPNELS - FALTDREGGEN  
Gegalvaniseerd

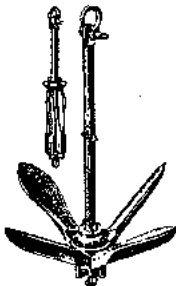

Gewicht $\pm$ Kgr.	1½	2½	4	7½	12
stuk Fr					

n°3006 DANFORTH ANKERS - ANGRES DANFORTH  
DANFORTH ANCHORS - DANFORTH ANKER  
Gegalvaniseerd



Gewicht $\pm$ lbs.	4½	10	17	30	43
Gewicht $\pm$ Kgr.	2	4½	7,7	13,6	19,5
stuk Fr					

Prijzen opgesteld den

Zonder Verbintenis



n°2905 KETTINGEN - CHAINES - CHAINS - KETTEN

Doormeters in mm.	3	4	5	6	7	8	10
Werkbelasting Kg.	85	150	235	339	462	603	943
Metrisch gewicht Kg.	0,17	0,37	0,56	0,80	1,09	1,40	2,20
Zwart per Kg. Fr							
Gegalv. per Kg. Fr							
Doormeters in mm.	12	14	16	18	20	22	25
Werkbelasting Kg.	1357	1847	2500	3054	3770	4560	5890
Metrisch gewicht Kg.	3,15	4,30	5,80	7,30	9,30	11.-	14.-
Zwart per Kg. Fr							

n°2906 HANGERKETTINGEN - CHAINES DE MARTINET  
PREVENTER CHAINS - HANGERKETTEN



Doorm. in mm.	25	28	32
Binnenafmet. mm.	40x156	45x175	51x200
Werkbelasting Kg.	3900	4900	6400
Metr. gewicht Kg.	11,7	14,64	17,44
Zwart per Kg.			

n°2943 KETTINGSTOPPERS - BOSSES DE CHAINE  
CHAINSTOPPERS - KETTENSTOPPER



Doorm. in mm.	8	10	12
Volle lengte M.	1,85	1,85	1,85
stuk Fr			

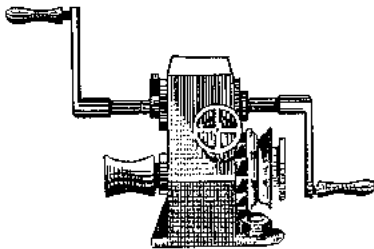

N° 2980

ANKERLIEREN - GUINDEAUX - WINDLASSES  
ANKERSPILLE

Gegalvan. met uitkoppelbaar kettingschijf

n°2980 dubbelwerkend vr. ketting  $\phi$  8 & 10 mm.  
stuk Fr

n°2981 enkelwerkend vr. ketting  $\phi$  6 mm.  
stuk Fr



n°3015 PROP ANKER - ANCRE DE CORPS MORT  
ONE ARMED ANCHOR

Zwart van  $\pm$  10 Kg. per Kg. Fr

n°3115 ANKERBOEIEN - BOUEES d'AMARRAGE  
MOORING BUOYS - VERTAUBOJEN  
Gegalvaniseerd

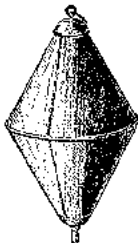

n° 3115

Hoogte cm.	50	70
stuk Fr		

Prijzen opgesteld den

ZONDER VERBINTENIS

STAALDRAADBLOKKEN - MOUFLES pr. CABLE en ACIER  
 STEELWIRE ROPE BLOCKS - DRAHTSEILBLÖCKE  
 met vasten beugel

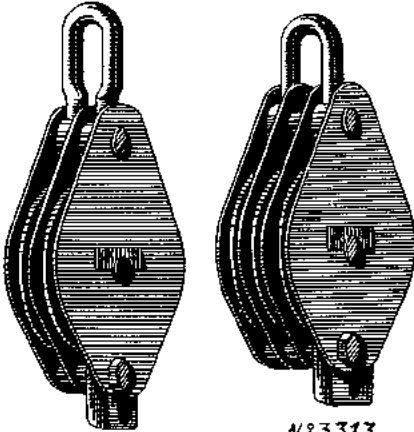

N<sup>o</sup> 3312

N<sup>o</sup> 3313

Ø schijf mm.	200	250	300	350
Ø schijf duim.	8	10	12	14
vr. draad Ø mm.	14	16	20	24
Nummer 3312		d	u	b
Werkbel. Tonnen	5	7	10	17½
Proefb. Tonnen	10	14	20	35
stuk Fr				
-----				
Nummer 3313		d	r	i
Werkbel. Tonnen	7½	10½	15	30
Proefb. Tonnen	15	21	30	50
stuk Fr				
=====				

n<sup>o</sup>2910 KETTINGWARTELS - EMERILLONS pr. CHAINE  
 CHAINSWIVELS - KETTENWIRBEL



N<sup>o</sup> 2910

Doormeter in mm.	8	10	13	16	19
Doormeter duimen	5/16	3/8	1/2	5/8	3/4
Werkbelasting Kg.	330	600	1140	1590	2400
vr. ketting Ø mm.	6	8	11	13	16
gewoon oog st. Fr					
groot oog st. Fr					
-----					
Doormeter in mm.	22	25	32	35	38
Doormeter duimen	7/8	1	1½	1.3/8	1½
Werkbelasting Kg.	3400	4500	5890	7390	9650
vr. ketting Ø mm.	19	22	25	28	32
stuk Fr					
=====					

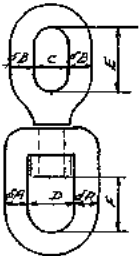

N<sup>o</sup> 2912

n<sup>o</sup>2912 LANGOGIGE WARTELS - EMERILLONS à OEILLETTS ALL.  
 OVAL EYES SWIVELS

m e r k t e e k e n s							
A	B	C	D	E	F	Werkb.T.	st.Fr
25	25	35	50	70	60	3	
32	29	38	60	78	80	5	
-----							

n<sup>o</sup>2675 KETTINGHAAK - CROC DE CHAINE - CHAINHOOK  
 KETTENHAKEN

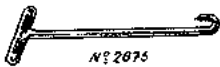

N<sup>o</sup> 2675

stuk Fr

n<sup>o</sup>2010 PLAATSCHALMEN - MAILLONS à 2 VIS  
 CONNECTING PLATES - SCHÄKEL mit 2 SCHRAUBEN



N<sup>o</sup> 2010

Doormeter vijs mm.	9,5	14,3	15,8
Doormeter vijs duimen	3/8	9/16	5/8
stuk Fr			
=====			

Prijzen opgesteld den

ZONDER VERBINTENIS

STAALDRAADBLOKKEN - MOUFLES pr. CABLES en ACIER - STEEL WIREROPE BLOCKS  
DRAHTSEILBLÖCKE

met warteloog

met wartelhaak

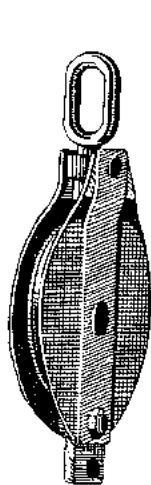

N° 3321

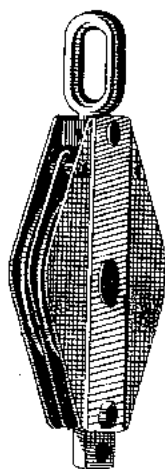

N° 3322

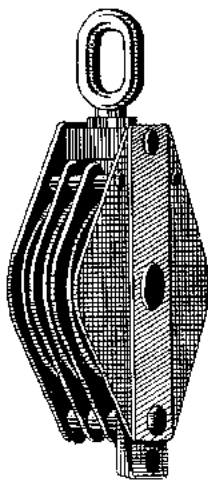

N° 3323

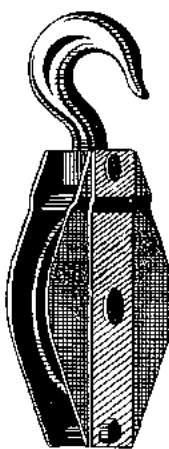

N° 3331

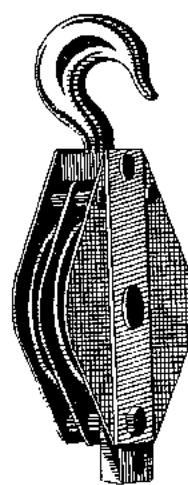

N° 3332

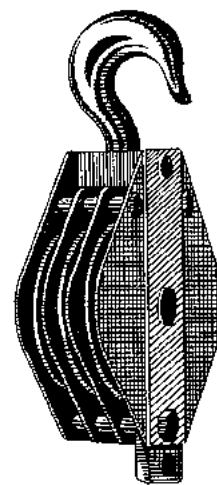

N° 3333

Ø schijf mm.	100	150	200	250	300	350
Ø schijf duimen	4	6	8	10	12	14
vr. draad Ø mm.	10	12	14	16	20	24
			E N K	E L		
Werkbel. Tonnen	$\frac{1}{2}$	1	$1\frac{1}{2}$	2	3	5
Proefbel. Tonnen	2	4	6	8	12	20
met oog st. Fr						
met haak st. Fr						
-----						
			D U B B	E L		
Werkbel. Tonnen	1	2	3	4	6	10
Proefbel. Tonnen	2	4	6	8	12	20
met oog st. Fr						
met haak st. Fr						
-----						
		D R I E D	U B B	E L		
Werkbel. Tonnen		2	3	4	6	10
Proefbel. Tonnen		4	6	8	12	20
met oog st. Fr						
met haak st. Fr						

schijven Ø 300 & Ø 350 voorzien van bronze bussen

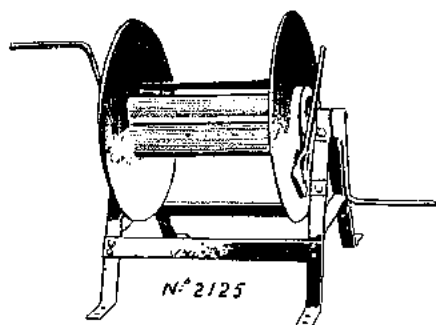

N° 2125

n° 2125 DRAADLIJEREN - TREUILS pr. CABLE  
WIREWINCHES - DRAHTSEILWINDEN

Afmetingen trommel	inhoud	stuk Fr
Ø 61 cm. x 50 cm. breed	90 Vad. 22	
Ø 70 cm. x 60 cm. breed	120 Vad. 24	

Prijzen opgesteld den

ZONDER VERBINTENIS



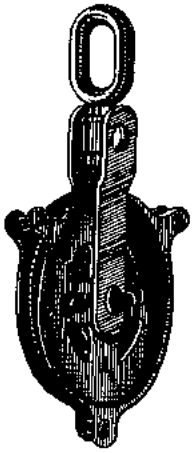

N°3301



N°3281

n°3301 LAADBLOKKEN  
POULIES DE MAT DE CHARGE  
CARGO BLOCKS - LADEBLÖCKE

n°3281 LEIBLOKKEN - POULIES DE RENVOI  
HEELBLOCKS - LEITBLÖCKE

∅ schijf mm.	250	300	350
∅ schijf duimen	10	12	14
vr. draad ∅ mm.	16	20	24
Werkbel. Tonnen	2	3	5
Proefbel. Tonnen	8	12	20
n°3301 stuk Fr			
n°3281 stuk Fr			

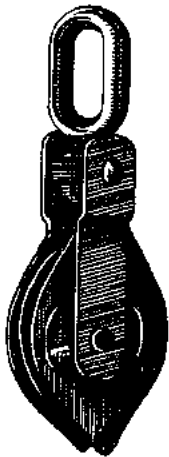

N°3351

n°3351 HANGERBLOKKEN - POULIES DE MARTINET  
TOP LIFT BLOCKS - HANGERBLÖCKE

∅ Schijf mm.	250	300	350	400
∅ Schijf duimen	10	12	14	16
vr. draad ∅ mm.	24	28	32	36
Proefbel. Tonnen	20	25	32	40
stuk Fr				



N°1850

n°1850 TRIANGELPLATEN - TREFLE DE CHARGEMENT  
UNION PLATES - HANGERPLATTEN

Dikte mm.	30	35
stuk Fr		



N°2951

n°2951 TANDWIELTAKELS - PALANS à ENGRENAGES DROITS  
SPURGEAR CHAIN BLOCKS - ZAHNRADFLASCHENZÜGE

Werkbelasting Kg.	500	1000
stuk Fr		

Prijzen opgesteld den

ZONDER VERBINTENIS



3415

n°3415 VOETBLOKKEN vr. STAALDRAAD  
 POULIES COUPEES pr. CABLE en ACIER  
 SNATCHBLOCKS for STEELWIRE ROPE  
 FUSSLÖCKE für DRAHTSEIL  
 met draairoog

Doormeter schijf mm.	150	200	250	300
Doormeter schijf duim.	6	8	10	12
vr. staaldraad $\varnothing$ mm.	16	20	24	28
Werkbelasting Tonnen	1	2	3	5
Proefbelasting Tonnen	4	8	12	20
stuk Fr				



3416

n°3416 VOETBLOKKEN vr. STAALDRAAD  
 POULIES COUPEES pr. CABLE en ACIER  
 SNATCHBLOCKS for STEELWIRE ROPE  
 FUSSLÖCKE für DRAHTSEIL  
 met draaihaak

Doormeter schijf mm.	150	200	250
Doormeter schijf duim.	6	8	10
vr. staaldraad $\varnothing$ mm.	16	20	24
Werkbelasting Tonnen	1	1½	2
Proefbelasting Tonnen	4	6	8
stuk Fr			

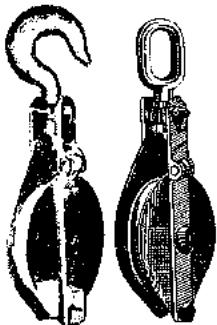

n°3405

n°3406

VOETBLOKKEN vr. KEMPTOUW  
 POULIES COUPEES pr. CORDAGE en CHANVRE  
 SNATCHBLOCKS for HEMPROPE  
 FUSSLÖCKE für HANFSEIL

Doormeter schijf mm.	120	160	190
Doormeter schijf duim.	4.3/4	6.1/4	7.1/2
vr. kemptouw $\varnothing$ mm.	20	24	28
Werkbelasting Tonnen	1/2	3/4	1
Proefbelasting Tonnen	2	3	4
n°3405 stuk Fr			
n°3406 stuk Fr			

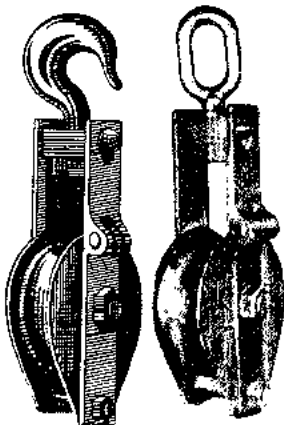

n°3410

3411

VOETBLOKKEN vr. TOOGTROSSEN IN KEMPTOUW  
 POULIES COUPEES pr. CABLE DE REMORQUE en CHANVRE  
 SNATCHBLOCKS for HEMP TOWROPE  
 FUSSLÖCKE für TROSSEN

Doormeter schijf mm.	140	190
Doormeter schijf duim.	5.1/2	7.1/2
vr. kemptouw $\varnothing$ mm.	36	64
vr. kemptouw omtrek	4.1/2"	8"
Werkbelasting Tonnen	3/4	2
Proefbelasting Tonnen	3	8
n°3410 stuk Fr		
n°3411 stuk Fr		

Prijzen opgesteld den

ZONDER VERBINTENIS

BLOKKEN vr. KEMPTOUW - MOUFLES pr. CORDAGE en CHANVRE  
 BLOCKS for HEMPROPE - HANFSEILBLÖCKE  
 met draaihaak met draai oog

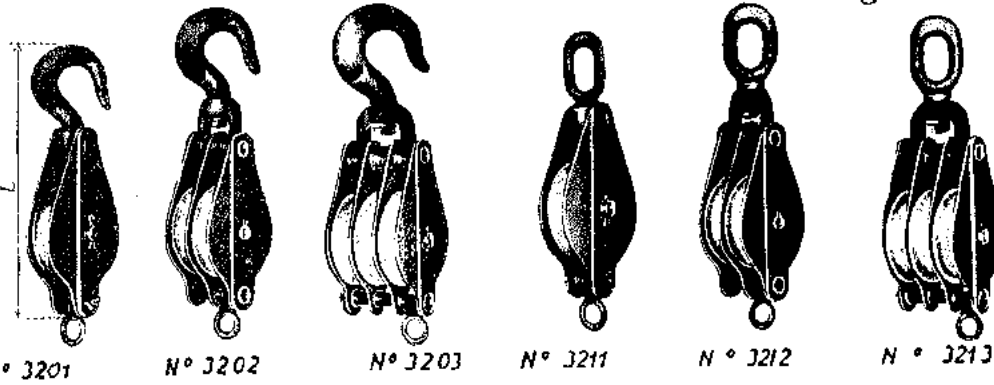

	N° 3201	N° 3202	N° 3203	N° 3211	N° 3212	N° 3213							
∅ schijf mm.	63	76	89	100	120	127	150						
∅ schijf duimen	2½	3	3½	4	4.3/4	5	6						
vr. touw ∅ mm.	10	11	13	16	19	22	25						
			E	N	K	E	L						
Werkbelasting Kg	35	50	75	125	250	250	500						
met haak stuk Fr													
met oog st. Fr													
				D	U	B	B	E	L				
Werkbelasting Kg.	100	150	250	500	750	1000	1500						
met haak stuk Fr													
met oog stuk Fr													
				D	R	I	E	D	U	B	B	E	L
Werkbelasting Kg.	150	250	500	750	1000	1500	2000						
met haak stuk Fr													
met oog stuk Fr													

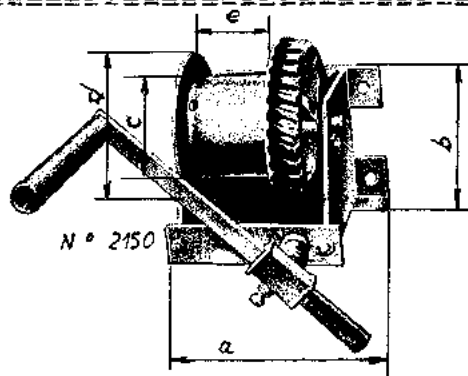

n°2150 MUURLIEREN - TREUILS MURAUX - WALLWINCHES - WANDWINDEN

Kracht Kg.	merkteekens					Hefhoogte per draaing	stuk Fr
	a	b	c	d	e		
250	375	190	150	185	175	62 mm.	
500	375	190	150	185	175	45 mm.	
1000	440	225	365	260	225	32 mm.	

Prijzen opgesteld den

ZONDER VERBINTENIS

GEALVAN. BLOKKEN - POULIES GALVANISEES  
 GALVAN. BLOCKS - VERZINKTE BLÖCKE

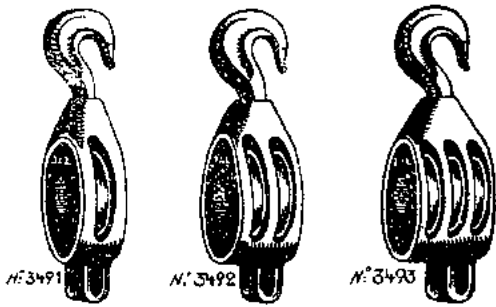

Nummer	6	7	8	9
Lengte kas mm.	150	175	200	225
vr. touw Ø mm.	18	20	22	24

Werkbelast.Kg.	200	500	750	
----------------	-----	-----	-----	--

n°3491 Haak				
n°3501 Oog				

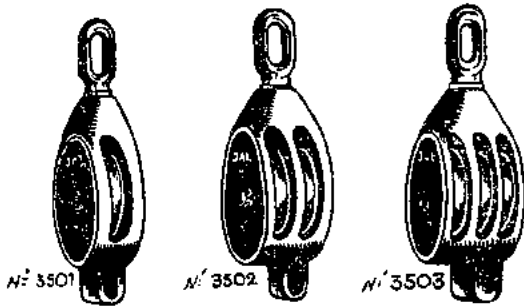

Werkbelast.Kg.	1000	1500	2000	2500
----------------	------	------	------	------

n°3492 Haak				
n°3502 Oog				

Werkbelast.Kg.				3500
----------------	--	--	--	------

n°3493 Haak				
n°3503 Oog				

GEALV. BLOKJES - PETITES POULIES GALVAN. - SMALL GALV. BLOCKS  
 VERZINKTE BLÖCKCHEN

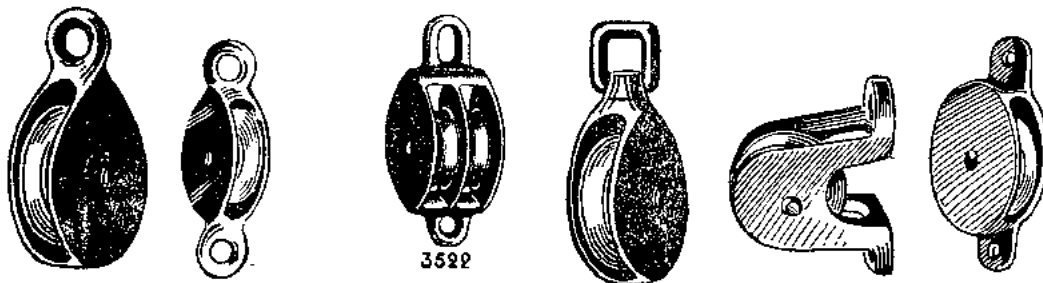

	3511	3521	3522	3551	3561	3571
Doorm. schijf mm.	20	25	30	40	50	70
vr. touw Ø mm.	6	7	8	10	12	14
n°3511 stuk Fr						
n°3521 stuk Fr						
n°3522 stuk Fr						
n°3551 stuk Fr						
n°3561 stuk Fr						
n°3571 stuk Fr						



n°3671 KOPEREN BLOKJES - PETITES POULIES en CUIVRE  
 SMALL COPPER BLOCKS - MESSING BLÖCKCHEN

Ø schijf 25 mm. vr. touw Ø 6 mm. st. Fr

Prijzen opgesteld den

ZONDER VERBINTENIS

HOUTEN YACHTBLOKJES - POULIES en BOIS pr. YACHTS - WOOD YACHTBLOCKS  
 HOLZENER YACHTBLÖCKE

Met koperen schijfjes en rollagers

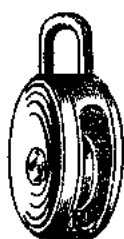

N°3631

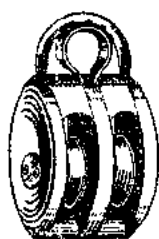

N°3632



N° 3641

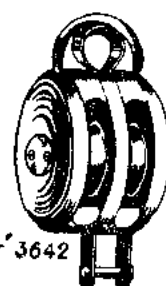

N° 3642

Lengte kas mm. vr. touw $\varnothing$ mm.	55 8	65 10	75 12	90 16	105 20
n°3631 stuk Fr					
n°3632 stuk Fr					
n°3641 stuk Fr					
n°3642 stuk Fr					

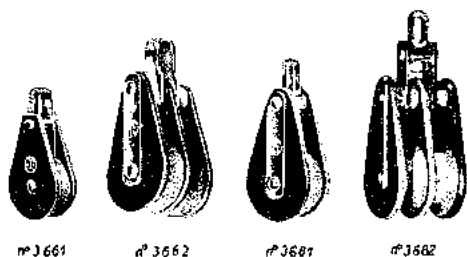

n°3661

n° 3662

n°3681

n°3682

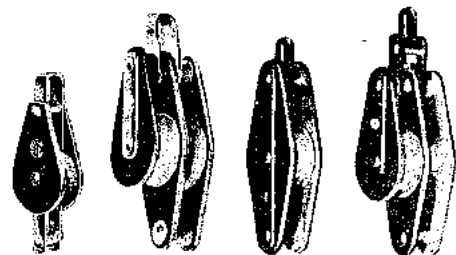

n°3691

n° 3692

n°3701

n° 3702

YACHTBLOKJES in HARDWEEFSEL  
 POULIES pr. YACHTS en FIBRE DUR  
 YACHTBLOCKS in HARDFIBRE  
 YACHTBLÖCKE in NOVOTEXT

$\varnothing$ schijf mm. vr. touw $\varnothing$ mm.	30 8	35 10	43 12	50 14
n°3661 stuk Fr				
n°3662 stuk Fr				
n°3681 stuk Fr				
n°3682 stuk Fr				
n°3691 stuk Fr				
n°3692 stuk Fr				
n°3701 stuk Fr				
n°3702 stuk Fr				

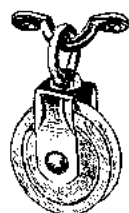

N° 3901

n°3901 BLOKJES met NYLON SCHIJF en WARTELOOG  
 POULIES avec REA en NYLON & OEILLET EM.  
 BLOCKS with NYLON SHEAVE & SWIVEL EYE  
 BLÖCKE mit NYLON ROLLE & DREHBAREM AUGE

$\varnothing$  schijf 45 mm. vr. touw  $\varnothing$  6 mm. st. Fr

Prijzen opgesteld den

zonder verbintenis

HOUTE BLOKKEN - POULIES EN BOIS - WOOD BLOCKS - HOLZBLÖCKE



3611



3612



3613



3621



N°3622

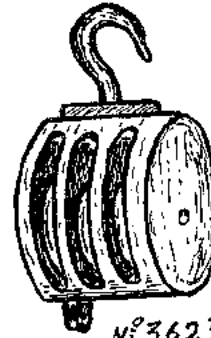

N°3623

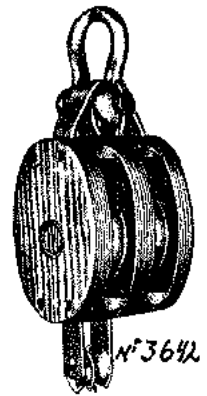

N°3642

Lengte kas duimen	4	5	6	7	8	9	10
Lengte kas mm.	102	127	152	178	203	228	254
vr. kemptouw Ø mm.	12	14	16	18	20	22	25
n°3611 Werkbel. Kg.	200	215	225	300	370	600	600
stuk Fr							
n°3612 Werkbel. Kg.	170	170	170				
stuk Fr							
n°3613 Werkbel. Kg.					1750		2600
stuk Fr							
n°3621 Werkbel. Kg.	100	150	250	300	500	650	800
stuk Fr							
n°3622 Werkbel. Kg.	200	300	500	600	1000	1300	1600
stuk Fr							
n°3623 Werkbel. Kg.							1600
stuk Fr							
n°3642 Werkbel. Kg.				800	1200	1500	2200
stuk Fr							

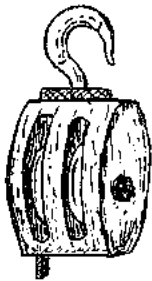

N°3652

n°3652 DUBBEL HOUTEN BLOKKEN 7" met HAAK  
Werkbelasting Kg. 475 met keur AIB  
vr. kemptouw Ø 18 mm.

POULIES DOUBLES en BOIS 7" avec CROCHET  
Travail normal Kg. 475 avec cert. AIB  
pr. cordage Ø 18 mm.

met gewone schijven stuk Fr  
met patent schijven stuk Fr



N°3835

n°3835 LUIKSPIEEN - COINS DE CALE - HATCHWEDGES  
HOLZKEILE

afmetingen 25 x 5½ x 6½ cm.

stuk Fr

Prijzen opgesteld den

ZONDER VERBINTENIS

n°3708 SCHIJVEN vr. KEMPTOUWWERK  
 REAS pr. CORDAGE EN CHANVRE  
 SHEAVES for HEMPROPE - HANFTAUSCHEIBEN

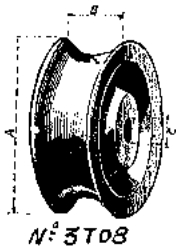

Doormeter in mm.	140	190
vr. touw $\emptyset$ mm.	36	64
dikte schijf mm.	48/51	80/83
brut stuk Fr		

n°3730 SCHIJFBUSSEN - DES DE REA - SHEAVEBUSHES  
 SCHEIBEBÜCHSEN

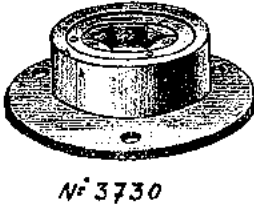

vr. as $\emptyset$ mm.	12,7	16	19
vr. as $\emptyset$ duimen	1/2	5/8	3/4
Hoogte mm.	16	22	25
stuk Fr			

n°3990 RATTESCHERMEN - GARDE-RATS - RATGUARDS  
 RATTENSCHIRME

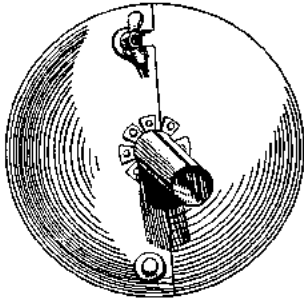

Doormeter cm.	62	75	91
stuk Fr			

KOPERE BOOTSNAGELEN  
 CLOUS DE BATEAUX EN CUIVRE  
 COPPER BOATNAILS -  
 KUPFERN BOOTSNÄGEL

in pakken van Kg. 5 brut

n°4150 met platte kop  
 afmetingen mm. { 19/2 25/2 32/2½ 38/2½  
 { 45/2½ 50/3



het pak brut/net per Kg. Fr  
 met minder net per Kg. Fr

n°4155 met diamant kop  
 afmetingen mm. { 19/2 25/2 32/2½ 38/2½  
 { 45/2½ 50/3 63/3 76/3

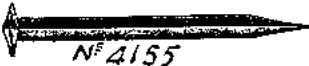

het pak brut/net per Kg. Fr  
 met minder net per Kg. Fr

n°4157 KOPERE SLUITRINGEN - RONDELLES EN CUIVRE  
 COPPER ROVES - KUPFERN SCHEIBCHEN  
 in pakken van Kg. 5 brut



het pak brut/net per Kg. Fr  
 met minder net per Kg. Fr

Prijzen opgesteld den

ZONDER VERBINTENIS

SCHIJVEN vr. STAALDRAAD - REAS pr. CABLE ACIER  
SHEAVES for STEEL WIRE ROPE - DRAHTSEILSCHEIBEN

t y p e n r . 3 7 0 6

∅ duimen	1	1½	2	3. 1/16	3¼	4	6
∅ mm.	30	40	50	80	82	100	150
vr. kabel ∅ mm.	5	5	5	8	6	10	12
dikte E mm.	10	10	10	13	11	18	21
dikte G mm.	10	10	10	13	14	20	24
gietijzer st. Fr							
koper stuk Fr							
∅ duimen	8	10	12	13	14	16	17
∅ mm.	200	250	300	330	350	400	435
vr. kabel ∅ mm.	14	16	20	20	24	28	32
dikte E mm.	24	28	37	41	45	46	54
dikte G mm.	27	31	40	44	48	55	57
gietijzer st. Fr							

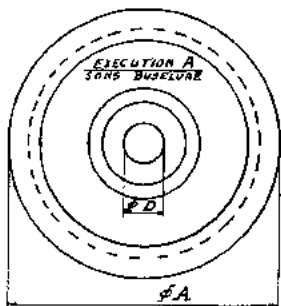

t y p e n r . 3 7 0 7

∅ duimen	6	8	10	12	14	16
∅ mm.	150	200	250	300	350	400
vr. kabel ∅ mm.	16	20	24	28	32	38
dikte E mm.	26	35	41	45	54	60
dikte G mm.	29	38	44	48	57	64
gietijzer st. Fr						

SCHIJVEN vr. KEMPTOUW - REAS pr. CORDAGE en CHANVRE  
SHEAVES for HEMPROPE - HANFTAUSCHEIBEN

∅ duimen	¾	1	1 3/16	1½	2	2¼	2¾
∅ mm.	20	25	30	40	50	57	70
vr. touw ∅ mm.	6	7	8	10	12	12	14
vr. as ∅ mm.	4	4	4	5	6	9½	9½
dikte schijf mm.	9	10	11	13	16	16	19
voor blokken						4"	5"
n°3705 galv.st.Fr							
n°3705 koper st.Fr							
n°3715 galv.st.Fr							
∅ duimen	3¼	4¼	4¾	5½	6¼	7½	
∅ mm.	82	108	120	140	159	190	
vr. touw ∅ mm.	16	18	20	22	25	28	
vr. as ∅ mm.	12½	12½	16	19	19	22	
dikte schijf mm.	22	24	26	28	30	32	
voor blokken	6"	7"	8"	9"	10"	12"	
n°3705 galv.st.Fr							
n°3715 galv.st.Fr							

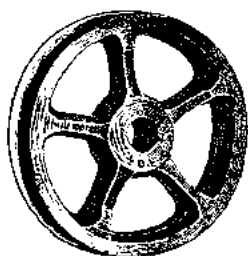

N°3705



N°3715

Prijzen opgesteld den

ZONDER VERBINTENIS



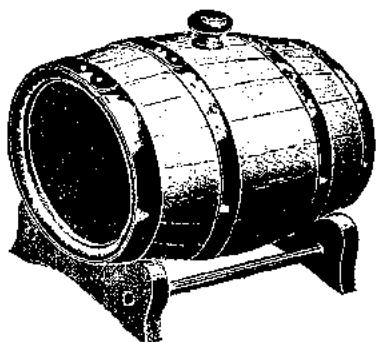

N<sup>o</sup> 3810

n<sup>o</sup>3810 WATERVATEN - BARILS DE GALERE  
 WATERBREAKERS - WASSERFÄSSCHEN  
 inhoud 40 lieter

stuk Fr

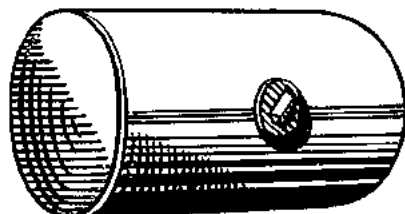

N<sup>o</sup> 4171

n<sup>o</sup>4171 GEGALVAN. WATERTANKS  
 RECIPIENTS à EAU GALVAN.  
 GALVAN. WATERTANKS  
 VERZ. WASSERTANKS

Afmet. in cm.	∅ 30x30	∅ 30x45	∅ 30x60
Inhoud Liet.	20	30	40
stuk Fr			



N<sup>o</sup> 3815

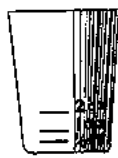

N<sup>o</sup> 3816

n<sup>o</sup>3815 GEEMAILL. WATERDIPPERS  
 EPUISSETTES EMAILLEES  
 ENAMELLED WATERDIPPERS  
 GEEMAILL. WASSERPLUMPEN

stuk Fr

n<sup>o</sup>3816 GEGRADUEERDE BEKERS  
 GOBELETS GRADUES  
 GRADUATED GOBLETS  
 GRADUIERTE BECHER

stuk Fr

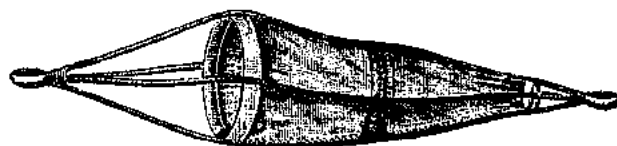

N<sup>o</sup> 1335

n<sup>o</sup>1335 DRIJFANKERS  
 ANCRES FLOTTANTES  
 SEA-ANCHORS  
 SEEANKER

∅ 61 cm. gewoon model st. Fr  
 ∅ 69 cm. groot model st. Fr

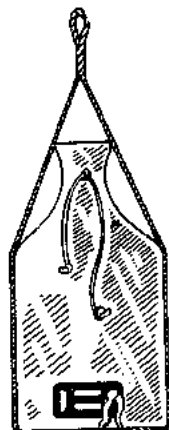

N<sup>o</sup> 1045

n<sup>o</sup>1045 OLIEZAKKEN - SACS à FILER l'HUILE  
 OILBAGS - ÖLSÄCKE

stuk Fr

Prijzen opgesteld den

ZONDER VERBINTENIS

n°3805 ESSEN ROEIRIEMEN - AVIRONS en FRENE - ASHOARS - RIEMEN

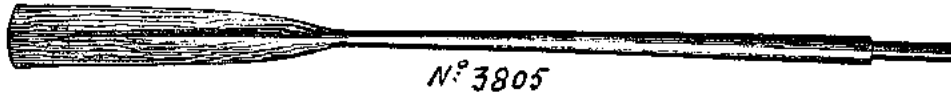

N°3805

Lengte in meters	1,83	2,15	2,45	2,75	3,05
Lengte in voeten	6	7	8	9	10
stuk Fr					
Lengte in meters	3,65	4,25	4,55	4,90	
Lengte in voeten	12	14	15	16	
stuk Fr					

n°3811 ENKELE PADDELS - PAGAIES SIMPLES - SINGLE PADDELS  
EINZIG PADDEL

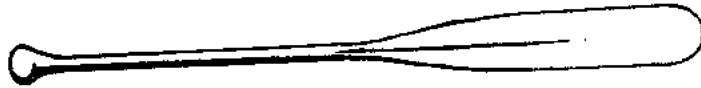

n° 3811

Lengte cm. 110 150  
stuk Fr

n°3812 DUBBELE UITNEEMBARE PADDELS - PAGAIES DOUBLES DETACHABLES  
DOUBLE PADDELS - DOPPEL PADDEL

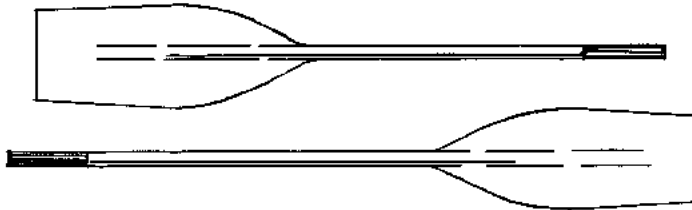

N° 3812

Lengte 240 cm. het paar Fr

n°4170 GEGALV. BESCHUITTANKS  
BOITES à BISCUITS GALVAN.  
GALVAN. BISCUITCASES  
ZWIEBACK TANKS

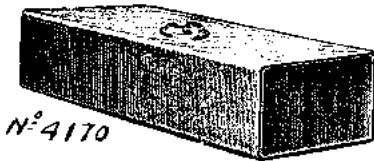

N°4170

maten in cm.	72x35x23	96x35x23
inhoud Kgr.	13	18
stuk Fr		



N°5500

n°5500 BESCHUITEN in DOZEN VAN ½ Kg.  
BISCUITS en BOITES DE ½ Kg.  
BISCUITS in TINS OF ½ Kg.  
ZWIEBACK in DOZEN Von ½ Kg.

de doos Fr

Prijzen opgesteld den

ZONDER VERBINTENIS

BOOTSTOPPEN - NABLES - BOATPLUGS  
LECKSCHRAUBEN

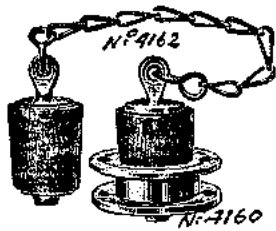

- n°4160 Pluggen stuk Fr  
n°4162 Stoppen het paar Fr

n°4165 Vijzende Bootstop stuk Fr



- n°3932 HOUTEN HOOSVATEN - ECOPEs en BOIS  
WOODBOATBAILERS - HOLZE ÖSFÄSSER  
stuk Fr

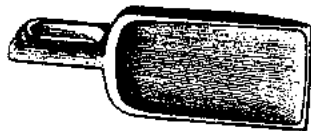

- n°2832 GEGALV. HOOSVATEN - ECOPEs GALVAN.  
GALVAN. BOATBAILERS - VERZ. ÖSFÄSSER  
stuk Fr

n° 3932



- n°3807 HOUTEN SPIEEN vr. VANGENLIJN  
CABILLOTS en BOIS pr. BOSSES  
WOOD TOGGLES for PAINTERS  
HOLZE KOFFEINÄGEL für LEINEN  
stuk Fr

N° 3807



- n°3808 HOUTEN HANDVATTEN - POIGNEES en BOIS  
WOOD HANDLES - HOLZE GRIFFE  
stuk Fr

N° 3808

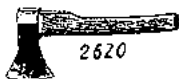

- n°2620 BIJLEN - HACHETTES - HATCHETS - BEILE  
gewicht  $\frac{1}{2}$  Kg.  
stuk Fr

2620



- n°2821 RINGBOUTEN vr. GRIJPLIJNEN  
PITONS à BOUCLE DE FILIERE  
LIFE LINE RINGBOLTS  
RINGBOLZE für GRIFFLEINEN  
stuk Fr

N° 2821

Prijzen opgesteld den

ZONDER VERBINTENIS



n°4025 STUURLICHTEN - LANTERNES DE ROUTE  
in blik stuk Fr



n°4041 STORMLANTAARNS - LANTERNES TEMPETE  
HURRICANE LAMPS - STURMLATERNE  
in blik stuk Fr

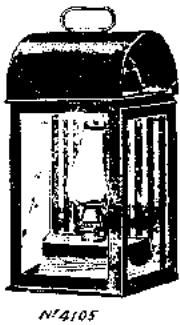

n°4105 MACHIENKAMERLANTAARNS - LANTERNES d'APPLIQUE  
BULKHEAD LAMPS - WANDLATERNE  
afmetingen 35x18x13 cm. lampglas 10"  
in blik stuk Fr  
in koper stuk Fr



n°4106 SCHOTLAMPEN - LAMPES d'APPLIQUE - BLACK LAMPS  
WANDLAMPE  
in blik stuk Fr



n°4110 KOPERE BALANCEERLAMPEN  
LAMPES A CARDAN EN CUIVRE  
BRASS GIMBAL LAMPS - BALANCIERLAMPE  
zonder rookscherf stuk Fr  
rookscherf vr. dito stuk Fr



n°4034 TORCHLAMPEN - LAMPES TORCHE - TORCHLAMPS  
elektrisch  
met 2 batterijen stuk Fr  
met 3 batterijen stuk Fr  
reserve batterij vr. dito stuk Fr  
Gloeilamp vr. dito stuk Fr

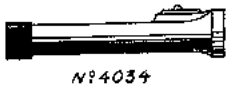

n°4000 WIEKSCHAAR - CISEAUX pr. MECHEs  
LAMP SCISSOR - LAMPENSCHERE  
stuk Fr

Prijzen opgesteld den

ZONDER VERBINTENIS



N<sup>o</sup> 4002.

n<sup>o</sup>4002 BOORDLANTAARNS - FEUX DE POSITION - SIDELAMPS  
SEITENLATERNEN

k o p e r

Afmetingen glas duim.	3x4	4 1/2 x 6	5x7
Afmetingen glas cm.	7 1/2 x 10	11 1/2 x 15	12 1/2 x 18
Petroleum paar Fr			
Petr. & Elektr. paar Fr			

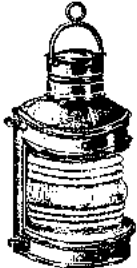

N<sup>o</sup> 4011

n<sup>o</sup>4011 TOPLANTAARNS - FEUX DE TETE DE MAT - MASTHEADS  
TOPPLATERNEN

k o p e r

Afmetingen glas duim.	3 1/2 x 4	4 1/2 x 5	5x6
Afmetingen glas cm.	9x10	11 1/2 x 12 1/2	12 1/2 x 15
Petroleum stuk Fr			
Petr. & Elektr. stuk Fr			



N<sup>o</sup> 4021

n<sup>o</sup>4021 ANKERLANTAARNS - FEUX DE MOUILLAGE - ANCHORLAMPS  
ANKERLATERNEN

k o p e r

Afmetingen glas duim.	3 1/2 x 4	4 1/2 x 5	5x6
Afmetingen glas cm.	9x10	11 1/2 x 12 1/2	12 1/2 x 15
Petroleum stuk Fr			
Petr. & Elektr. stuk Fr			



N<sup>o</sup> 4022

n<sup>o</sup>4022 HEKLANTAARNS - FEUX DE POUPE - STERNLAMPS  
HECKLATERNEN

k o p e r

Afmetingen glas duim.	3x4	3 1/2 x 5	4 1/2 x 6
Afmetingen glas cm.	7 1/2 x 10	9 x 12 1/2	11 1/2 x 15
Petroleum stuk Fr			
Petr. & Elektr. stuk Fr			

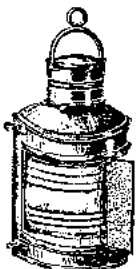

N<sup>o</sup> 4009

n<sup>o</sup>4009 Koper, petroleum, glas 3 1/2" x 4" stuk Fr  
n<sup>o</sup>4010 Koper, elektriek, glas 3 1/2" x 4" stuk Fr

Passend lampglas	5"	6"	10"
Passend gloeilamp	10W	10W	10W

TWEEKLEURLANTAARNS - FEUX BICOLORES  
BICOLOUR LAMPS - ZWEILICHTLATERNEN

n<sup>o</sup>4031 BOLLANTAARNS - LANTERNES à BOULE - GLOBE LAMPS

Bolglas (doormeter)	7"	7"	7"	8"	10"
	helder	rood	groen	helder	helder
Gegalv. Petr. st. Fr					
Koper Petr. st. Fr					
Koper Elektr. st. Fr					

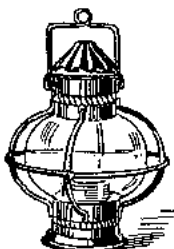

N<sup>o</sup> 4031

Prijzen opgesteld den

ZONDER VERBINTENIS

n°4004 BOORDLANTAARNS - FEUX DE POSITION - SIDELAMPS  
SEITENLATERNEN



N°4004

k o p e r & e l e k t r i e k

Afmetingen glas duimen	2.1/4 x 3	3 x 4
Afmetingen glas cm.	6 x 7.1/2	7.1/2 x 10
paar Fr		

n°4005 TOPLANTAARNS - FEUX DE TETE DE MAT - MASTHEADS  
TOPPLATERNEN



N°4005

k o p e r & e l e k t r i e k

Afmetingen glas duimen	2.1/4 x 3	3 X 4
Afmetingen glas cm.	6 x 7.1/2	7.1/2 x 10
stuk Fr		

n°4013 ANKERLANTAARNS - FEUX DE MOUILLAGE  
ANCHORLAMPS - ANKERLATERNEN



N°4013

k o p e r & e l e k t r i e k

Afmetingen glas duimen	2.1/4 x 3	3 X 4
Afmetingen glas cm.	6 x 7.1/2	7.1/2 x 10
stuk Fr		

n°4023 HEKLANTAARNS - FEUX DE POUPE - STERNLAMPS  
HECKLATERNEN



N°4023

k o p e r & e l e k t r i e k

Afmetingen glas duimen	2.1/4 x 3	3 X 4
Afmetingen glas cm.	6 x 7.1/2	7.1/2 x 10
stuk Fr		

passend gloeilamp) klein groot  
baïonet )

STROOMLIJN YACHTLANTAARNS  
PANAUX pr. YACHTS AERODYNAMIQUES  
STREAMLINE YACHTLAMPS  
STROMLINIEN YACHTLAMPEN

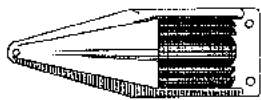

n°4006

n°4006 Elektr. Boordlantaarns verchroomd, Lengte  
Lengte 170 mm., dioptr. glas 70 x 60 mm.  
paar Fr



N° 4007

n°4007 Elektr. Toplantaarns verchroomd  
Lengte 230 mm., dioptr. glas 70 x 60 mm.  
stuk Fr



N°4024

n°4024 Elektr. Yachtlantaarns verchroomd  
Lengte 170 mm., effen glas 50 x 50 mm.  
Boord-, Top-, Heklantaarns stuk Fr

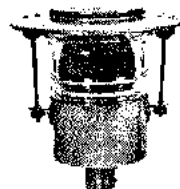

N° 4030

n°4030 SIGNAALLANTAARNS - FEUX DE SIGNALISATION  
elektriek - dioptriek glas 3 1/2 x 4"

Oranje glas met schakelaar stuk Fr  
Helder glas, knipperlicht stuk Fr

Prijzen opgesteld den ZONDER VERBINTENIS



EGALV. EMMERS - SEAUX GALVANISES  
GALVAN. BUCKETS - VERZINKTE EIMER

- n°2830 Emmer vr. huishouden 12 L. stuk Fr  
n°2831 Schippersemmer 7 L. stuk Fr  
n°2831R dito met versterkingsband stuk Fr

n°4050 OLIEPOMPEN - POMPES à HUILE - OILPUMPS  
ÖLPUMPE  
stuk Fr

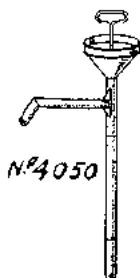

n°4051 KOPEREN BOOTSPOMPEN  
POMPES DE CANOT EN CUIVRE  
BRASS BOATPUMPS  
MESSING PUMPE

Afmetingen in mm.	Ø 35x450	Ø 35x600
stuk Fr		

n°4054 PLASTIC POMPEN - POMPES en PLASTIC  
PLASTIC PUMPS - PLASTIC PUMPE

Afmetingen in mm.	Ø 40x300	Ø 40x600
stuk Fr		

n°4055 WATERDARMEN - TUYAUX pr. POMPES  
HOSES - SCHLAUCH

Binnendoormeter mm.	15	18
de meter Fr		

n°4060 DARMKLEMMEN - COLLIERS DE SERRAGE  
HOSE CLIPS - SCHLAUCHKLEMME

Buitendoormeter mm.	25	32
stuk Fr		

n°4052 VLEUGELPOMPEN - POMPES SEMI ROTATIVES  
SEMI ROTARY PUMPS - HALB ROTATION PUMPE

Nummers	0	1	2	3
Maat mondstuk	3/4"	3/4"	1"	5/4"
slagen per minuut	104	100	88	82
Debiet per uur L.	1200	1750	2350	3100
stuk Fr				

n°4053 POMPEN - POMPES - PUMPS - PUMPE  
" STEP ON IT "

Zuighoogte 0,2 M. - Pershoogte 4 M.  
stuk Fr

n°4056 SMEEROLIEKANNEN - BURETTES à HUILE  
OILFEEDERS - SCHMIERKANNE

Inhoud Lieters	1/3	1/2	1
stuk Fr			

Prijzen opgesteld den

ZONDER VERBINTENIS

n°3970 OLIEKANNEN - CANETTES à HUILE - OILFILLERS  
ÖLKANNE



N° 3970

Inhoud liters	3	5	10
Materiaal	blik	gegalvan.	gegalvan.
stuk Fr			

n°4082 TRECHTERS - ENTONNOIRS - FUNNELS - TRICHTER  
materiaal blik



N° 4082

Doormeter in mm.	160	200	240
zonder zeef st. Fr			
met zeef stuk Fr			

n°4035 FAKKELS - TORCHES - FLARE-UPS - FACKEL  
stuk Fr

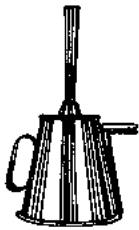

N° 4035

MISTHOORNS - CORNETS DE BRUME - FOGHORNS  
NEBELHORN



N°2825



- n°2825 Mondmishoorn in zink stuk Fr  
Mondmishoorn in koper st. Fr  
n°2826 Mekanische Mishoorn stuk Fr

n°2827 ROEPHOORNS - MEGAPHONES - MEGAPHONES  
SPRACHROHR



N°2827

	zonder mondst.		met mondstuk	
Lengte cm.	35	40	55	
in blik stuk Fr				
in koper stuk Fr				



N° 2840

n°2840 KLOKKEN - CLOCHES - BELLS - GLOCKEN

Doorm. cm.	12	19	22	24
stuk + Kg.	1,2	4	8½	13½
stuk Fr				

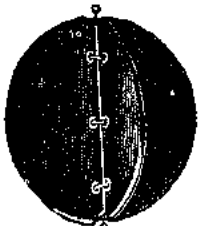

N° 2610

n°2610 SIGNAALBALLONS - DISQUES pr. SIGNAUX  
SIGNALSHAPES - SIGNALBALL

- Doormeter 61 cm. in zeildoek stuk Fr  
Doormeter 61 cm. in plaat stuk Fr

Prijzen opgesteld den

ZONDER VERBINTENIS





n°590

n°589 VALSCHERMSIGNALEN - SIGNAUX PARACHUTES  
PARACHUTE SIGNALS - FALLSCHIRM SIGNALE  
stuk Fr

n°590 ROOKSIGNALEN - SIGNAUX FUMIGENES  
SMOKE SIGNALS - RAUCH SIGNALE  
stuk Fr



n°595

n°595 RODE LICHTEN - FEUX ROUGES - RED LIGHTS  
ROTFEUERN  
de doos van 6 stuks Fr

n°591 VUURPIJLEN - FUSEES - ROCKETS - RAKETTEN  
van 16 ozs. de doos van 6 stuks Fr



n°592



n°597

n°596 KNALSIGNALEN - PETARDS - SHOOT SIGNALS  
KNALLSIGNALS  
de doos van 6 stuks Fr

REDDINGSBOEILICHTEN - FEUX DE BOUEES  
LIFEBUOYLIGHTS - RETTUNGSBOJENLICHT  
n°592 met carbuur stuk Fr  
n°597 elektrisch stuk Fr

n°593 LUCIFERS - ALLUMETTES - MATCHES  
STREICHHÖLZCHEN  
onuitbluschbaar  
de doos Fr



n°593



n°600

n°600 SIGNAALSPIEGEL - MIROIR DE SIGNALISATION  
SIGNALLING MIRROR - SIGNALSPIEGEL  
stuk Fr



n°4500

n°4500 TELEGRAAFKetting - CHAINE pr. TELEGRAPHE  
TELEGRAPHCHAINS - TELEGRAPHKETTE  
n°4 de meter Fr



n°4510

n°4510 SCHAKELS vr. TELEGRAAFKetting  
MAILLONS pr. CHAINE DE TELEGRAPHE  
TERMINALS  
n°4 stuk Fr

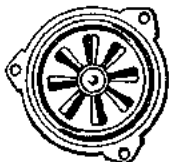

n°4077

n°4077 VENTILATIEROZETTEN - LOUVRES d'AERATION  
BULKHEAD VENTILATOR - ENTLUFTUNGSROSETTE  
Verchromd

Buiten doorm. mm.	100	125	150
stuk Fr			

Prijzen opgesteld den ZONDER VERBINTENIS

n°4061 OPENDRAAIENDE PATRIJSSPOORTEN  
 HUBLOTS OUVRANTS  
 PORT LIGHTS  
 KAJUTFENSTER  
 brons

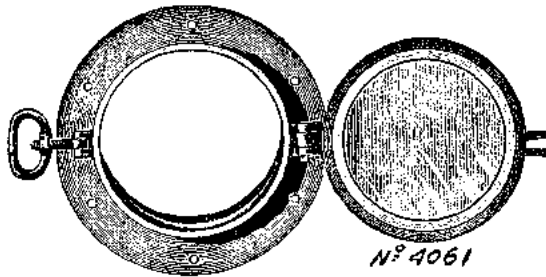

Doorm. dag mm.	100	150
stuk Fr		
met ring 4071		
stuk Fr		

n°4071 PLATTE RINGEN - ANNEAUX PLATS  
 FLAT RINGS - FLACHE RINGE  
 koper zonder glas

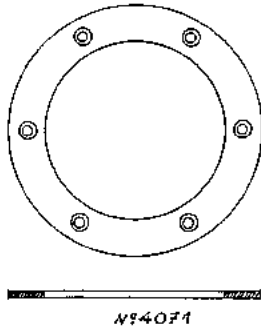

Doorm. dag mm.	100	125	150	180
Buiten Ø mm.	145	175	200	240
stuk Fr				

n°4072 LICHTRANDEN - HUBLOTS FIXES  
 FIXED LIGHTS - FENSTERRINGE  
 brons

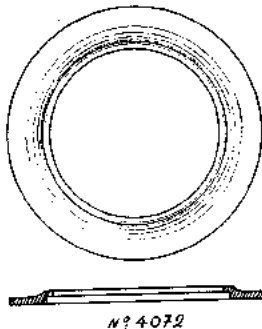

Ø dag mm.	100	150	175	200
buiten Ø mm.	150	225	250	280
stuk Fr				
glas stuk Fr				

n°4075 LUCHTHELMEN - MANCHES A AIR  
 VENTILATING COWLS - WINDHUZE  
 koper

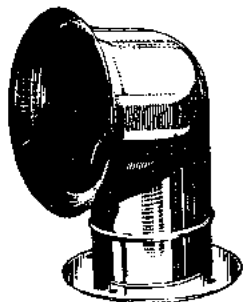

Binnen Ø mm.	70	100	125
stuk Fr			
dop vr. dito			
stuk Fr			

DEKVENTILATOREN - CHAMPIGNONS d'AERATION  
 MUSHROOM VENTILATORS - ENTLÜFTER  
 brons

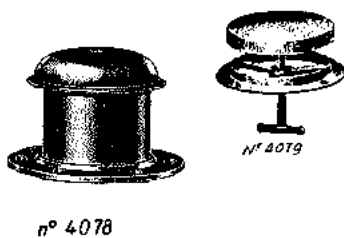

n°4078 binnen Ø 100 x 160 mm. volle hoogte  
 stuk Fr

n°4079 binnen Ø 80 mm. stuk Fr

Prijzen opgesteld den

ZONDER VERBINTENIS

GASVERSTELLERS - MANETTES pr. MOTEURS  
CONTROLLEVERS - GASRÉGLER

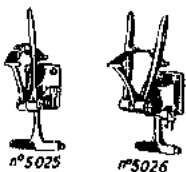

- n°5025 enkel verchroomt stuk Fr  
n°5026 dubbel verchroomt stuk Fr  
n°5029 enkel verchroomt stuk Fr  
n°5030 dubbel verchroomt stuk Fr

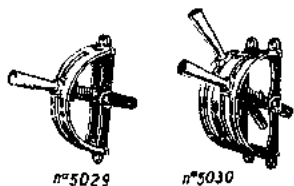

n°5055 HOUTEN STUURRADEREN - ROUES DE GOUVERNAIL  
STEERING WHEELS - STEUERRAD

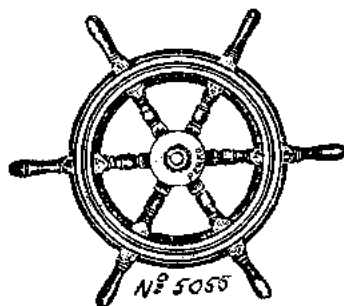

Buiten Ø cm.	45	50	60	80
Koper Besl.				
Chrom. Besl.				

LINTMETERS - METRES RUBANS - TAPELINES  
ROLLBANDMASSE

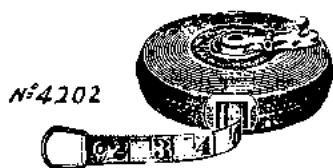

- n°4202 Linnen band met ingelegden koperdraad  
lederen omhulsel, meters & duimen

Lengte meters	10	20
Lengte duimen	33	66
stuk Fr		

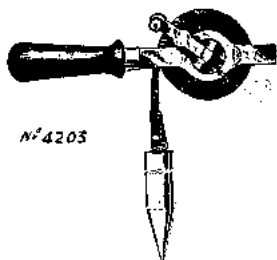

- n°4203 Roestvrijen band, afneembaren punt  
gemerkt duimen, lengte 66 voet

stuk Fr

n°4200 TOUWMETERS - GAUGE à COULISSE pr. CABLES  
ROPE GAUGES

stuk Fr



- n°4201 VOUWBARE PEILSTOKKEN - SONDES PLIABLES  
PLIABLE SOUNDING RODS - FALTBARE EICHSTÄBE

Lengte 36 duimen, gemerkt duimen

stuk Fr



Prijzen opgesteld den

ZONDER VERBINTENIS

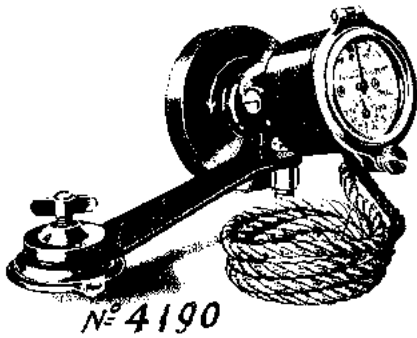

n°4190 SCHEEPSLOGGEN - LOCH DE BATEAU  
SHIPS LOGS - SCHIFFSLOG

Walker's Excelsior Ship Log IV

bevattende: 1 kasje  
1 klok  
2 attachen  
1 Haak  
30 M. lijn  
1 schroef  
1 lood vr. lijn  
1 oliebusje

stuk Fr

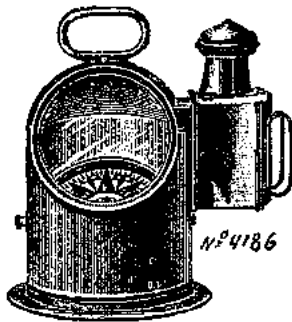

n°4186 VLOEISTOF KOMPASSEN  
BOUSSOLES LIQUIDES  
LIQUID COMPASSES - KOMPASS

Roosdiam. 4" met koperen nachthuis

stuk Fr



n° 4195

n°4195 PEILLOODEN - PLOMBS DE SONDE  
SOUNDING LEADS - PEILLOT

van Kg. ±	2	3,15	6,5	12,5
per Kg. Fr				



N° 930

n° 930 LOODLIJNEN - LIGNES DE SONDE  
LEADLINES - LOTLEINE

Handloodlijn - Petite ligne de sonde  
Handleadline - Handlotleine  
30 vadems Ø 8 mm. stuk Fr  
merken stuk Fr

Diepzeeloodlijn  
Grande ligne de sonde  
Deapsealeadline - Tieflotleine  
120 vadems Ø 12 mm. stuk Fr  
merken stuk Fr



N° 3945

n°3945 LOODLIJNWIELEN  
TREUILS pr. LIGNE DE SONDE  
LEADLINE REELS - LOTLEINROLLE

vr. handloodlijn stuk Fr  
vr. diepzeeloodlijn stuk Fr



n°4325 SCHROEFTEERKOPPEN  
TETES DE BROSE à GOUDRONNER  
TARBRUSHES - TEERKÖPFE

Doormeter  $\varnothing$  55 mm. stuk Fr  
Doormeter  $\varnothing$  60 mm. stuk Fr

n°4334 STELEN vr. SCHROEFTEERKOPPEN  
MANCHES pr. TETE de BROSE à GOUDRONNER  
HANDLES for TARBRUSHES  
TEERKOPFSTIELE

Lengte 1M.60 x  $\varnothing$  30 mm. stuk Fr  
Lengte 2M.50 x  $\varnothing$  30 mm. stuk Fr  
in Bamboe lengte 3M.60 x  $\varnothing$  31/38  
zonder beslag stuk Fr  
met beslag stuk Fr  
in Bamboe lengte 5 M. x  $\varnothing$  30/35  
zonder beslag stuk Fr  
met beslag stuk Fr



n°4210 STRAATKEERDERS - BROSSES DE RUE  
BASS BROOMS - BAHIA BESEN  
stuk Fr

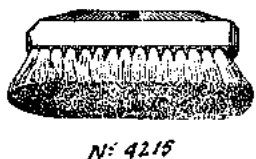

n°4215 SCHUURBORSTELS - BROSSES à RECURER  
DECK SCRUBBERS - SCHEUERBÜRSTE  
stuk Fr



n°4220 COCOKEERBORSTELS - BALAIS en COCO  
COIR BROOMS - KOKOBÜRSTE  
stuk Fr



STALEN BORSTELS - BROSSES EN ACIER  
WIRE BRUSHES - STAHLBÜRSTE

n°4240 handborstel met regelaar stuk Fr  
n°4241 handborstel met handvat & regel. st. Fr  
n°4242 schuurborstels stuk Fr



n°4330 BORSTELSTELLEN - MANCHES pr. BROSSES  
BROOMHANDLES - BÜRSTELSTIELE  
Lengte 1M.25 x  $\varnothing$  30 mm. stuk Fr

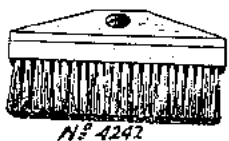

n°4225 HANDVLEUGELS - BROSSES à EPOUSSETER  
BANNISTER BRUSHES

in chiendent stuk Fr  
in tula stuk Fr



n°4235 HANDSCHUURBORSTELS -  
BROSSES à RECURER à MAIN  
HANDSCRUBBERS - HANDSCHEUERBÜRSTE  
in chiendent stuk Fr



Prijzen opgesteld den

ZONDER VERBINTENIS

n°4120 KOPERE ZEILKOUSJES - OEILLETS pr. BACHES  
BRASS EYELETS - MESSING SEGEL KAUSCHE



Nummers	20	21	22	23	24	25	26
Buiten Ø mm.	11	13	14	16	17	19	21
Binnen Ø mm.	6	7	8	9	10	11	12
Hoogte mm.	5	6	6	6	6	6	7
het gros Fr							



N°4121

Nummers	27	28	29	30	31	33	35
Buiten Ø mm.	22	24	25	29	32	38	46
Binnen Ø mm.	12	13	14	17	18	21	25
Hoogte mm.	7	8	8	8	10	10	13
het gros Fr							

n°4121 MATRIJZEN vr. KOPERE ZEILKOUSJES  
MATRICES pr. OEILLETS pr. BACHES  
PUNCH & DIES for BRASS EYELETS  
MATRIZE für SEGELKAUSCHE

Nummers {	20	21	22	23	24	25	26
stuk Fr	00	0	1	2	3	4	5
Nummers {	27	28	29	30	31	33	35
stuk Fr	6	7	8	9	10	12	14



n°4080 BRANDELUSSERS - EXTINGTEURS  
FIRE EXTINGUISHERS - AUSLÖSAPPARAAT

Inhoud 1 Lieter stuk Fr

n°2622 KOEIVOETEN - PIEDS DE BICHE - CROWBARS - KUHFUSS  
in staal

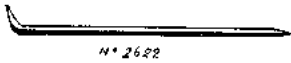

N° 2622

Lengte 0M.60 x Ø 18 mm. stuk Fr  
Lengte 1M.15 x Ø 30 mm. stuk Fr

n°4205 STOKDWEILEN - VADROUILLES - MOPS - LAPPENBESEN

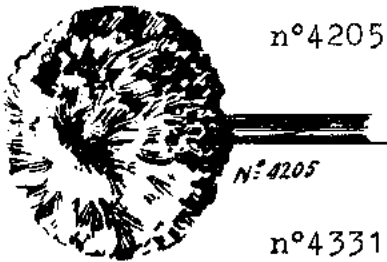

N° 4205

in wol gekleurd stuk Fr  
in katoen wit stuk Fr  
in katoen gekleurd stuk Fr

n°4331 STOKDWEILSTELLEN - MANCHES pr. VADROUILLE  
MOPHANDLES - LAPPENBESENSTIEL

Lengte 1M.60 x Ø 30 mm. stuk Fr

n°4327 BOKKEPOOTJES - PIEDS DE BOUC  
TARBRUSHES with HANDLE - TEERKOPF mit STIEL



N° 4327

Ø kop 35 mm. stuk Fr  
Ø kop 40 mm. stuk Fr

Prijzen opgesteld den

ZONDER VERBINTENIS

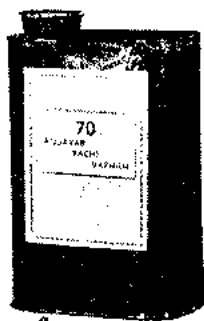

N° 401

n°401 YACHTVERNIS - VERNIS pr. YACHT  
YACHTVARNISH - YACHTFIRNIS

bus van  $\frac{1}{2}$  Lieter stuk Fr  
Bus van 1 lieter stuk Fr

n°402 ROESTWERENDE VERF - PEINTURE ANTI-CORROSIVE  
ANTI-CORROSIVE PAINT - ROSTSCHUTZFARBE

bus van Kg. 1 stuk Fr

n°403 AANGROEIWERENDE VERF  
PEINTURE ANTI-SALISSANTE  
ANTI-FOULING PAINT  
ANWUCHSCHUTZFARBE

Bus van Kg. 1, rood stuk Fr  
Bus van Kg. 1, groen stuk Fr



N° 404

n°404 COPPERPAINT bussen van Kg. 1

Kleur	rood	groen	brons
de bus Fr			

n°405 YACHTLAK - EMAIL pr. YACHT - YACHTENAMEL  
YACHTLACK

wit, in bussen van Kg. 1 de bus Fr

n°406 ANTISLIPVERF - PEINTURE ANTI-DERAPANTE  
ANTI-SLIPPAINT - ANTIGLITSCHFARBE

de bus van 0,57 L. Fr

n°407 ONTVERVER - DEVERNISSEUR - PAINTREMOVER

de bus van  $\frac{1}{2}$  Lieter Fr  
de bus van 1 Lieter Fr



N° 451

n°451 LIQUID MARINE GLUE

Voor het overtrekken met zeildoek van dek, kabiendaken enz. Pour couvrir de toile pont, toit de cabine etc.  
5 lieters bestrijken ongeveer 10 M2

Bussen van {	1 Pint	1 Quart	$\frac{1}{2}$ Gall.	1 Gall.
de bus Fr	0,57 L.	1,14 L.	2,27 L.	4,54 L.

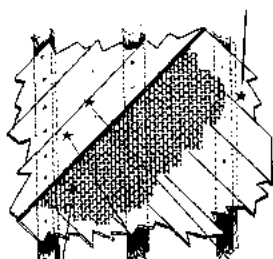

n° 452

n°452 HYDRO, om te gebruiken tussen dubbele beplanking  
pour usage entre double bordage  
5 Lieters bestrijken ongeveer 10 M2

Bussen van {	1 Pint	1 Quart	$\frac{1}{2}$ Gall.	1 Gall.
de bus Fr	0,57 L.	1,14 L.	2,27 L.	4,54 L.

Prijzen opgesteld den

ZONDER VERBINTENIS

n°454 SEAMFLEX

Kleuren: Wit, Zwart, Geel, Teak & Mahoniehout  
Couleurs: Blanc, Noir, Jaune, Teak & Acajou

Voor het inleggen van deklichten en voor op te stoppen. Pour poser des verres de pont et tous usage de bouchage.

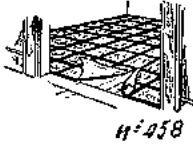

Bussen van {	1 lb.	2 lb.	5 lb.
de bus Fr	0,45 Kg.	0,90 Kg.	2,27 Kg.

n°458 FERROFIX

Voor het vastkleven van linoleum, kurk, vilt enz. op hout of ijzer. Pour coller linoleum, feutre, liège etc. sur fer ou sur bois.

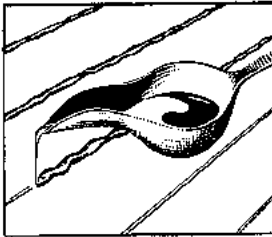

Bussen van {	1 Pint	1 Quart	½ Gall.
de bus Fr	0,57 L.	1,14 L.	2,27 L.

JEFFERY'S MARINE GLUE in bussen van 25 Kg., prijzen per Kg.

Kleur	z w a r t				w i t		
Kwaliteit	n°1	n°2	n°3	Navigation	n°1	n°2	n°3
per bus							
met minder							

TEERPRODUKTEN - PRODUITS DU GOUDRON

- n°501 UMEA 3 Kr. gonnen van 125 L.
- n°505 ZWEEDSE TEER kwal. W vaten ± 200 Kg.
- n°506 ZWEEDSE TEER kwal.SM.vaten ± 200 Kg.
- n°515 KOOLTEER vaten ± 200 Kg.
- n°510 ZWARTE VERNIS vaten ± 200 Kg.
- n°520 CARBOLINEUM vaten ± 200 Kg.
- n°526 ZWEEDSE PEK vaten van + 165 Kg.  
per 1/1 vat brut/net  
per 1/2 vat brut/net
- n°547 KOOLPEK vaten van + 70 Kg.
- n°548 MASTIEK G vaten ± 70 Kg.

Prijs het Kg.		
per vat	per 25 Kg. & +	minder als 25Kg

Prijzen opgesteld den

ZONDER VERBINTENIS



KALFAATWERK - ETOUPE à CALFATER - OAKUM  
SCHIFFWERG

in balen van 25 Kg.

Prijs het Kg.	
per baal	met minder



n°1117 kwal. extra getwijnd

n°1118 kwal. prima in band

n°1111 KALFAATKATOEN - COTON à CALFATER  
CAULKING COTTON - KALFATBAUMWOLLE  
in bollen van 250 grammen

per bol Fr  
mer Kg. Fr



n° 2530-1-2

KALFAATIJZERS - BURINS à CALFAT  
CAULKING IRONS - KALPATEISEN

n°2529 schuine kalfaatiijzer st. Fr

n°2530 kalfaatiijzer effen st. Fr

n°2531 kalgaatiijzer met 1 ril st. Fr

n°2532 kalfaatiijzer met 2 rillen st. Fr

n°2533 kalfaatiijzer met 3 rillen st. Fr

n°3930 KALFAATHAMERS - MAILLETS à CALFATER  
CAULKING MALLETS - KALFATHAMMER

stuk Fr

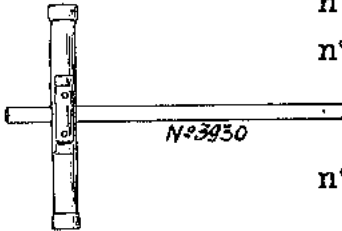

N°3930

n°2450 PEKLEPELS - CUIILLERS à POISSER  
PITCHLADLES - PECHLÖFFEL

stuk Fr

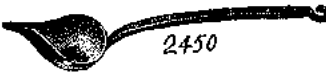

2450

n°2451 ELEKTRISCHE PEKLEPELS  
CUIILLERS à POISSER ELECTRIQUES  
ELECTRIC PITCHLADLES  
ELEKTRISCHE PECHLÖFFEL

Wissel of gelijkstroom  
Volt 100/120 200/230 230/250

stuk Fr

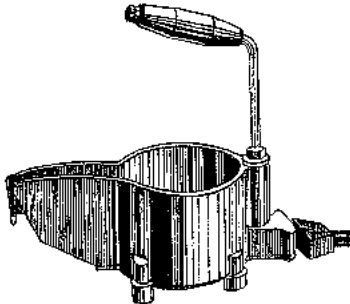

n° 2451

n°2460 PEKPOTTEN - POTS à POIX - PITCHPOTS  
PECHTOPF

stuk Fr



N°2460

n°2437 DEKSTENEN - BRIQUES DE PONT - DECKSTONES  
SCHEUERSTEINE

Afmetingen 23x12x10 cm.

stuk Fr

n°2435 RAMEN vr. DEKSTENEN  
CHARPENTES pr. BRIQUES DE PONT  
FRAMES for DECKSTONES

stuk Fr



N°2435

n°4336 STELEN vr. dito - MANCHES pr. dito  
HANDLES for dito - STIEL für dito

stuk Fr

Prijzen opgesteld den

ZONDER VERBINTENIS

Produits " FORM FLEX " Produkten

Synthetische rubber verkregen door het homogeen mengen van 2 Samenstellingen, weerstaat aan zee-water, minerale produkten en weers-omstandigheden. Verharding op 8 U. bij 10°C., 3 U. bij 20°C., 1 U. bij 35°C. - Synthetische rubber verkregen na 72 U. bij 10°C., 36 U. bij 20°C., 12 U. bij 35°C.

Caoutchouc synthétique obtenu par le mélange homogène de 2 compositions, résistant à l'eau de mer, produits minéraux et in-tempéries. Durcissement obtenu en 8 Hres. par 10°C., 3 Hres. par 20°C., 1 Hre. par 35°C. - Caoutchouc synthétique obtenu après 72 Hres. par 10°C., 36 Hres. par 20°C., 12 Hres. par 35°C.

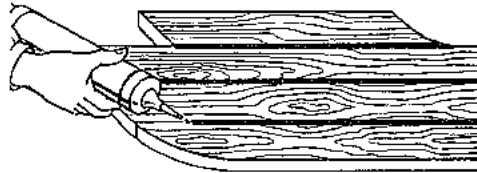

n°425 FORM FLEX BS 101 S

de bus van KG.1 Fr

le bidon de Kg.1 Fr

Zwarte pasta voor deknaden op te vullen met spatel of speciale pomp. Naden laten overvloeien. Synthetische rubber effen maken met scherp gereedschap. Specifiek gewicht 1,3. Naden eerst bestrijken met vooraanstrijk Primer.

Pâte noire pour coutures de pont à appliquer avec une spatule ou une pompe spéciale en la laissant déborder des coutures. Egalez le caoutchouc avec un outil tranchant. Poids spécifique 1,3. Coutures à enduire d'une 1re couche " Primer ".

n°426 FORM FLEX

WS 60 Bruin) bus van Kg.1 Fr  
BS 60 Zwart)

WS 60 brun) le bidon de Kg.1 Fr  
BS 60 noir)

Pasta voor rompnaden op te vullen met spatel of speciale pomp. Wordt toegepast op hout, metalen, glas, beton. Specifiek gewicht 1,5. Geen Primer nodig.

Pâte pour coutures de coques à appliquer avec une spatule ou une pompe spéciale sur bois, métaux, verres, bétons. Poids spécifique 1,5. Il ne faut pas de Primer.

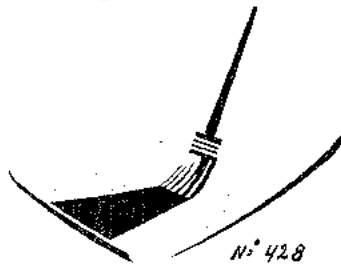

n°428 FORM FLEX T.A.

Zwart de bus van KG.1 Fr

Noir le bidon de Kg. 1 Fr

Vloeibaar. Voor het dicht maken hout, metalen, beton te bestrijken met borstel op spuit of door indompeling. 1 Kg. nodig voor 1,5 tot 3 M2.

Liquide à appliquer sur une surface à rendre étanche à la brosse, au pistolet, par immersion sur bois, métaux, bétons. 1 Kg. couvre 1,5 à 3 M2.

Prijzen opgesteld den

ZONDER VERBINTENIS

Produits " FORMFLEX " Produkten  
n°420 P R I M E R

de bus van 0,07 Kg. st. Fr  
de bus van 0,25 Kg. st. Fr  
de bus van 0,50 Kg. st. Fr

le bidon de 0,07 Kg. pce. Fr  
le bidon de 0,25 Kg. pce. Fr  
le bidon de 0,50 Kg. pce. Fr

Vooraanstrijk op zuivere en droge naden te bestrijken, welke men zal opvullen met Formflex BS 101 S (n°425), 1 laag op zacht hout, 2 lagen op hard hout. Verhouding 1 Kg. voor 7 tot 14 Kg. Formflex.

Première couche à appliquer sur les coutures sèches et propres de pont, qu'on compte enduire de Formflex BS 101 S (n°425), 1 couche sur bois tendre, 2 couches sur bois dur. Proportion 1 Kg. pour 7 à 14 Kg. de Formflex

n°410 BESTRIJKSEL vr. ZEILEN - ENDUIT pr. BACHES  
Kleuren: Kleurloos, bruin en groen

Bussen van Kg.	1	5
de bus Fr		

n°411 TEXTIELLIJM - COLLE pr. TEXTILES - CANVASGLUE - TEXTILLEIM  
de bus van Kg. 1 Fr

n°560 VISOLIE - HUILE DE POISSON - FISHOIL - FISCHÖL  
per vat van + 200 Kg. net Kg. Fr  
met 25 Kg. en meer net Kg. Fr  
met minder dan 25 Kg. net Kg. Fr

n°576 DIERENVET - GRAISSE ANIMALE - TALLOW - TIERISCHES FETT  
in klompen van 10 Kg. het Kg. Fr

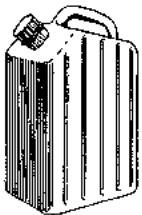

n° 395



n°395 JERRYCANS in PLASTIEK - JERRYCANS en PLASTIQUE  
bestand tegen petroleumprodukten

Inhoud lieters	5	10	20
stuk Fr			

n°5200 OPBLAASBARE KANO'S - CANOTS PNEUMATIQUES  
in katoendoek van binnen gevulcaniseerd



" JUNIOR " - 1 Persoon  
Buitenafmetingen 1,50 x 0,94 M.  
Binnenafmetingen 1,05 x 0,45 M.  
gewicht Kg. 3

stuk Fr

" SENIOR " - 2 personen  
Buitenafmetingen 1,95 x 1,15 M.  
Binnenafmetingen 1,35 x 0,53 M.  
gewicht Kg. 5

stuk Fr

POMP vr. dito st. Fr

Prijzen opgesteld den

ZONDER VERBINTENIS

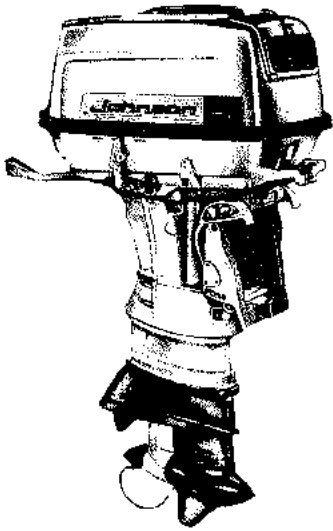

n°5350

n°5350 BUITEN BOORD MOTOREN  
MOTEURS HORS BORD  
OUTBOARD MOTORS  
AUSSENBORD MOTOREN

Prijzen en Folders op aanvraag

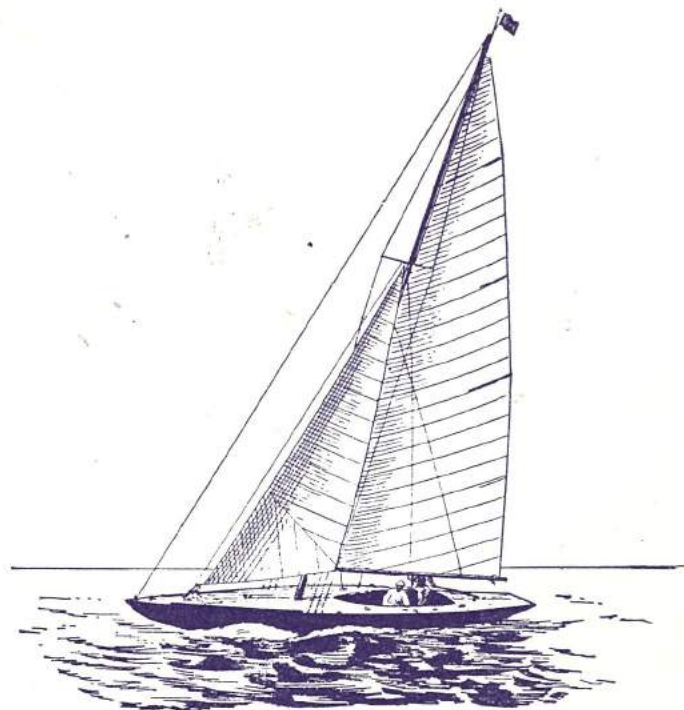

*Voor uwe zeilen, raadpleeg ons.*

*Pour vos voilures, consultez-nous.*